

NON ORIGINAL REPLACEMENT PARTS FOR :
SAME-LAMBORGHINI-HÜRLIMANN

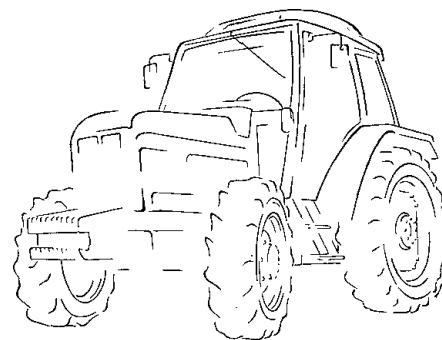

SAME

LAMBORGHINI

HÜRLIMANN

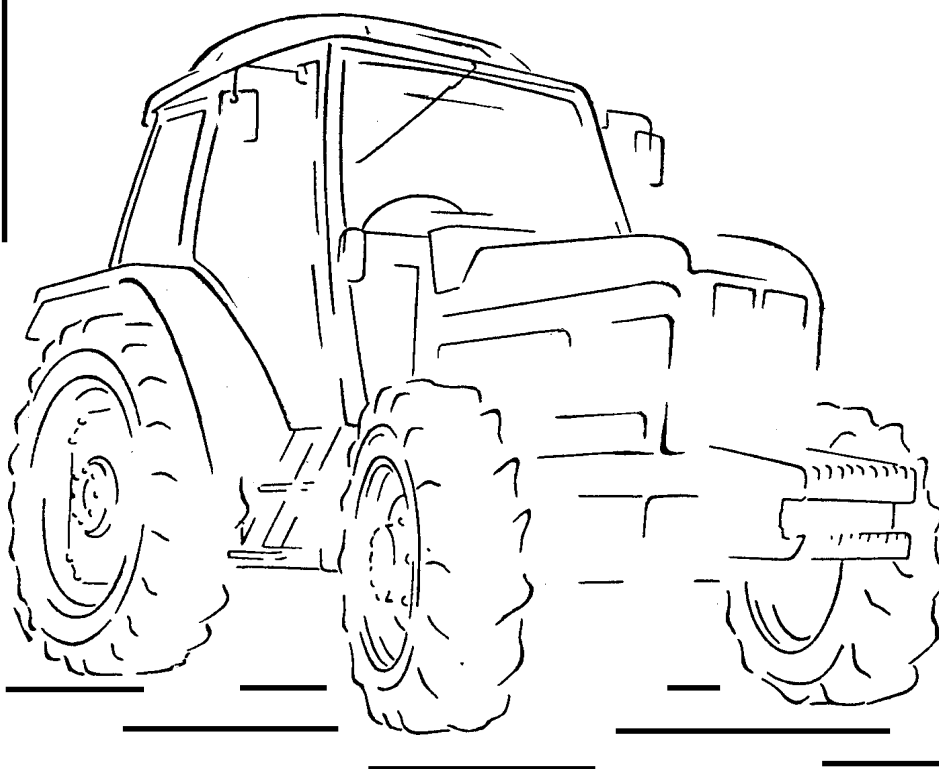

NEW/29/2.0-FE

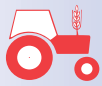
**AGRIPIECES**Tel.: +(33) 553 96 31 25
Fax: +(33) 553 68 03 72**Agripieces Sud-Ouest Distribution s.a.**

Zone Industrielle Agen Boe, B.P. 5 - F-47240 Bon-Encontre (France)

**TRACPIECES**Tel.: +(33) 327 83 53 12
Fax: +(33) 327 81 23 13**Tracpieces France s.a.**

P.A. Fontaine Notre Dame - F-59406 Cambrai (France)

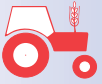
**TRACPIECES**Tel.: +(32) 085 27 80 80
Fax: +(32) 085 27 80 81**Tracpieces Benelux s.a.**

36, rue J. Delhalle - B-4520 Wanze (Belgique/Belgïe)

Tel.: +(44) 12 99 25 2200
Fax: +(44) 12 99 25 2201**Bepco Group**

Hartlebury Trading Estate - DY104JB Worcestershire (UK)

Tel.: +(44) 15 44 23 1144
Fax: +(44) 15 44 23 1484**Bepco (U.K) Ltd.**

Hatton Gardens Industrial Estate - HR5 3RB Kington (UK)

**TRACPIECES**Tel.: +(49) 5251 77 903 66
Fax: +(49) 5251 77 903 77**Tracpieces Ersatzteile GmbH**

Steinbruchweg, 13 - D-33106 Paderborn (Deutschland)

**TRACPIECES**Tel.: +(31) 413 293 975
Fax: +(31) 413 294 087**Tracpieces Nederland b.v.**

Den Dolvert, 10 - NL-5473 GP Heeswijk-Dinther (Nederland)

**EURESAS**Tel.: +(34) 93 381 00 62
Fax: +(34) 93 381 33 45**Europea de Recambios s.a.**

Av. M. Fernandez Marquez, s/n Nave 4, 1 ° - 08930 San Adrian del Besos (España)

Tel.: +(61) 397 96 54 22
Fax: +(61) 397 96 52 51**Bepco Australasia (Head office)**

Factory 5, 1 Melverton Drive - Hallam 3803 Victoria (Australia)

Tel.: +(27) 11 3975386/9
Fax: +(27) 11 3973039**Bepco South Africa (Pty) Ltd.**

CNR Rudo Nell / Kelly St. - Jet Park Boksburg, Johannesburg (South Africa)



S.L.H PARTS

Flotteur de réservoir - Fuel sender unit - Tankschwimmer - Tankvlotter - Flotador

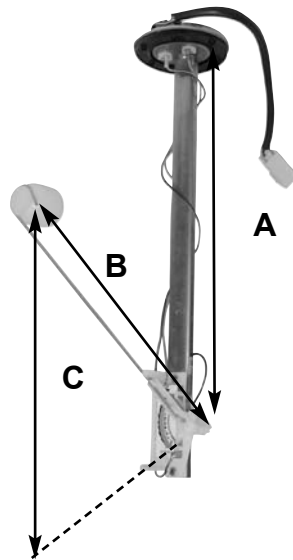









	Part N°	Oem	Observation
Frutteto 60II, 75II, 85II 660F, 775F PLUS H361, H476-F	29/172-102	2.7059.590.0/10	A : 280mm - B : 235mm C : 452mm - 6 Holes





SAME PARTS

Optiques - Front lights - Frontscheinwerfer - Koplamp - Faros delanteros

Part N°		Fig.	
 29/189-60 280297100/02	1x 63/1955-410 12V 45/50W Asym. - Asim.		
 29/189-61 280297400/21	1x 63/1955-472 H4 12V 55-60W		
 29/189-62 280297600/30	1x 63/1955-472 H4 12V 55-60W		ARGON 50, 55, 60, 65, 70, 75F DORADO 55, 60, 65, 70, 75, 85 EXPLORER II 60, 70, 80, 90T FRUTTETO 60, 75, 85II GOLDEN 60, 65, 75, 85 COMPATTO GOLDEN 60V, 75V KRYPTON 80, 90, 100 KRYPTON F 78M, 78N, 78C, 88M, 88N, 88C, 98M, 98N, 98C ROCK 50, 60, 70 ROW CROP 100.6 RUBIN 120, 135, 150 SILVER 80, 90, 100.4, 100.6, 110, 130



Phare - Headlamp - Werklamp
Scheinwerfer - Faro



Cabochon - Glass - Glas
Glas - Tulipa



Ampoule - Bulb - Gloeilamp
Glühlampe - Bombilla

Les références des pièces sont indicatives.
Nos pièces ne sont pas d'origine.

Part numbers are quoted for reference purposes only.
Our parts and accessories are not original.





SAME (SUPPLEMENT)

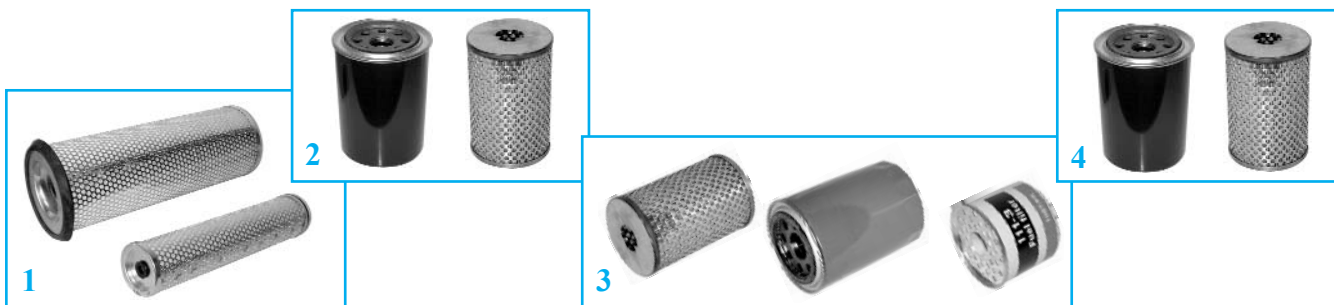

Tracteurs Tractors	1		2	3	4
	Air		Huile Oil	Combustible Fuel	Hydraulique Hydraulic
	Ext. / Out.	Int. / Inn.			
Frutteto I 60, 75	60/161-112 (242493401)	60/162-112 (242493402)	60/97-36 (04415670, 04415510)	60/111-3 (243190601) (Repl. CAV 296)	60/240-69 (244192800, 244193500)
Frutteto I 85			60/97-22 (244193400)		
Frutteto II 60, 75	60/161-104 (242491300, 242491310, 242493100/10, 242493104)	60/162-25 (242491302, 242491307, 242491309)	60/97-36 (04415670, 04415510)		
Frutteto II 85			60/97-22 (244193400)		
Golden 60, 65, 75, 85			60/111-25 (00946870)		
Dorado 70			60/97-36 (04415670, 04415510)	60/111-3 (243190601)	

Les références des pièces sont indicatives.
Nos pièces ne sont pas d'origine.

Part numbers are quoted for reference purposes only.
Our parts and accessories are not original.



SAME (SUPPLEMENT)

Les références des pièces sont indicatives.
Nos pièces ne sont pas d'origine.

*Part numbers are quoted for reference purposes only.
Our parts and accessories are not original.*

INDEX

ALTERNATEURS 75-76	ALTERNATORS 75-76
BAGUES D'ETANCHEITE 83	BEARINGS (AIR COOLING) 1
BOUGIES DE PRECHAUFFAGE 11	BRAKES 58-63
BOUTONS POUSSOIRS 41	BUTTONS 41
CONTACTEURS DIVERS 15	CABS ELEMENTS 80
COURROIES DE VENTILATEUR 14	CLUTCH ASSEMBLIES & PLATES 45-55
COUSSINETS (REFROIDISSEMENT PAR AIR) 1	COVER SEAL 83
DEMARREURS 77	ENGINE GASKET & BEARINGS SETS (WATER COOLING) 2
DISTRIBUTEURS HYDRAULIQUES 73	ENGINE GASKET SETS (AIR COOLING) 7-8
ECHAPPEMENTS 35	FAN BELTS 14
ECLAIRAGE - FEUX ARRIÈRES 39	FILTERS 16-34
ECLAIRAGE - FEUX DE POSITION & CLIGNOTANTS 38	FLANGE & SPLINED AXLES 65
ECLAIRAGE - PHARES AVANTS 36-37	FUEL PUMPS & REPAIR KITS 9-10
ECLAIRAGE - PHARES DE TRAVAIL 40	GAS STRUTS 81-82
ELEMENTS DE CABINES 80	HEATER PLUGS 11
ETAIS A GAZ 81-82	HYDRAULIC PUMPS 70-72
FILTRATION 16-34	HYDRAULIC VALVE 73
FLASQUE & MANCHONS CANNELES 65	INJECTOR NOZZLES 11
FREINAGE 58-63	INSTRUMENTS (MISCELLANEOUS) 42-44
INSTRUMENTS DE BORD 42-44	LIFTING RODS 74
JOINTS & COUSSINETS DE MOTEUR (EAU) 2	LIGHTING - REAR LIGHTS 39
JOINTS DE MOTEUR (AIR) 7-8	LIGHTING - FRONT LIGHT 36-37
KITS DE DIRECTION ASSISTEE 65	LIGHTING - PLOUGH LAMPS 40
MAITRE CYLINDRE 50	LIGHTING - SIDE LIGHTS & INDICATORS 38
MECANISMES ET DISQUES D'EMBRAYAGE 45-55	MASTER & SLAVE CYLINDERS (CLUTCHES) 50
NEZ D'INJECTEURS 11	MISCELLANEOUS PARTS FOR «BOSCH» GENERATOR 76
PEINTURE 79	MISCELLANEOUS PARTS FOR ORIGINAL ALTERNATORS 76
PIECES DE RECHANGE POUR DEMARREURS «BOSCH» 78	PAINT 79
PIECES DETACHEES POUR EMBRAYAGES VALEO 56	PISTONS, ... (WATER COOLING) 5-6
PIECES DIVERSES POUR ALTERNATEURS D'ORIGINE 76	PISTONS, ... (AIR COOLING) 3-4
PIECES DIVERSES POUR DYNAMO «BOSCH» 76	POWER STEERING KITS 65
PISTONS, ... (REFROIDISSEMENT PAR AIR) 3-4	PTO DRIVE 57
PISTONS, ... (REFROIDISSEMENT PAR EAU) 5-6	REPLACEMENT PARTS FOR VALEO CLUTCHES 56
POMPES A EAU 12-13	SEAT 79
POMPES D'ALIMENTATION & KITS DE REPARATION 9-10	SILENCERS 35
POMPES HYDRAULIQUES 70-72	SPARE PARTS FOR «BOSCH» STARTER MOTORS 78
PTO 57	STABILISERS 73
ROTULES & TIRANTS DE DIRECTION 66-69	STARTER MOTORS 77
SIÈGE 79	STEERING LINKS & SOCKETS 66-69
STABILISATEURS 73	SWITCHES (MISCELLANEOUS) 15
TIRANTS DE RELEVAGE 74	TRANSMISSION 64
TRANSMISSION 64	WATER PUMPS 12-13

Les références des pièces sont indicatives.
Nos pièces ne sont pas d'origine.

Part numbers are quoted for reference purposes only.
Our parts and accessories are not original.



"THE RELIABLE SERVICE"



COUSSINETS (REFROIDISSEMENT PAR AIR)
BEARINGS (AIR COOLING)

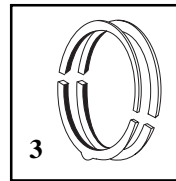
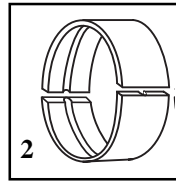
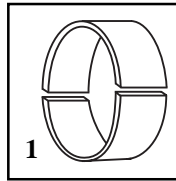

SAME

Figures	1	2	3
Tracteurs <i>Tractors</i>	Coussinets de bielle <i>Conrod bearings</i> (Par cyl. / Per cyl.)	Coussinets de palier <i>Main bearings</i> (Par palier / Per hub)	Epaisseurs latérales <i>Thrust washers</i> (Par mot. / Per engine)
Aurora, Buffalo 120, Corsaro, Delfino (1973 ⇄), Drago 100, 120, Falcon, Minitauro, Minitauro 60, Panther, Saturno, Sirenetta (1973 ⇄), Laser 150, Hercules, Galaxy Solar 50, 60, Tiger 100, Moteurs 982, 983, 984, 985, 986, 1052, DA 1053, 1054, 1055, 1056 <i>Engines</i>	062.1225K (2x 062.1225.0) Larg. / Width : 27mm	073.1215K (2x 029.1215.0) Larg. / Width : 32mm	042.1218K (2x 042.1218.0 + 2x 042.1219.0)
Antarès 100, 110, 130 Aster 60, Explorer 60, 70, 80, 90, Frutteto 60, 75, Solar 60C, Vigneron 62, 75, Moteurs 1053P, 1000.3A, 1000.4A, 1000.6A <i>Engines</i>	065.1225K (2x 065.1225.0) Larg. / Width : 29mm	065.1216K (1x 065.1215.0 + 1x 065.1216.0) Larg. / Width : 26,25mm	065.1218K (4x 065.1218.0)

LAMBORGHINI

Figures	1	2	3
Tracteurs <i>Tractors</i>	Coussinets de bielle <i>Conrod bearings</i> (Par cyl. / Per cyl.)	Coussinets de palier <i>Main bearings</i> (Par palier / Per hub)	Epaisseurs latérales <i>Thrust washers</i> (Par mot. / Per engine)
R235, C362, C453, C533, C553, R503, R603, R653, C653, R654, R754, R784, R854, R955, R1156, R1356, R1556	062.1225K (2x 062.1225.0) Larg. / Width : 27mm	073.1215K (2x 029.1215.0) Larg. / Width : 32mm	042.1218K (2x 042.1218.0 + 2x 042.1219.0)

Coussinets & épaisseurs latérales disponibles en côte réparation.
Bearings and thrust washers are available in oversize.



JOINTS & COUSSINETS DE MOTEUR (REFROIDISSEMENT PAR EAU)
ENGINE GASKET & BEARINGS SETS (WATER COOLING)

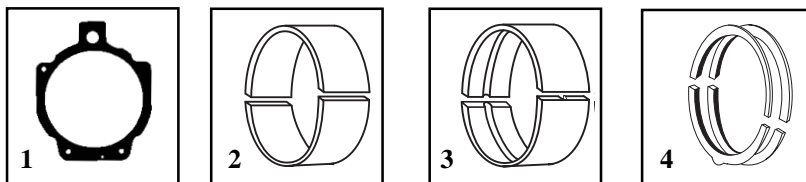

LAMBORGHINI

Figures		1	2	3	4
Tracteurs Tractors	Pochette complète Full gasket set	Joint de culasse Cyl. head gasket (Par cyl. / Per cyl.)	Coussinets de bielle Conrod bearings (Par cyl. / Per cyl.)	Coussinets de palier Main bearings (Par palier / Per hub)	Epaisseurs latérales Thrust washers (Par mot. / Per engine)
R.674, R.674.5, C.674, R.774, C.774, 774-5 (4 cyl.)	066.0050.6 (A)	078.1451.0 Languette sans trou Strip less hole Ep./Thick. : 1,2mm			
R.956, R.956-100, R.1106, R.1306 (6 cyl.)	078.0050.6 (A)				
R.674-70, R.674-70N, C.674-70 Grand-Prix, R.774-80, R.774-80N, C.774-80, C.774-80 Grand-Prix, C.874-70T, C.874-90T Grand-Prix, L.105 (4 cyl.)	089.0050.6 (A)	078.1452.0 Languette avec 2 trous Strip with 2 holes Ep./Thick. : 1,4mm	065.1225K (2x 065.1225.0)	065.1216K (1x 065.1215.0 + 1x 065.1216.0)	065.1218K (4x 065.1218.0)
L.115, Formula 115, L.135, Formula 135, 6135 Elite (6 cyl.)	337.0050.6 (A)	078.1453.0 Languette avec 1 trou Strip with 1 hole Ep./Thick. : 1,6mm			
R.1506, R.1706 (6 cyl.)	064.0050.6 (B)	057.1456.0	062.1225K (2x 062.1225.0)	073.1215K (2x 029.1215.0)	042.1218K (2x 042.1218.0 + 2x 042.1219.0)

HÜRLIMANN

Figures		1	2	3	4				
Tracteurs Tractors	Pochette complète Full gasket set	Joint de culasse Cyl. head gasket (Par cyl. / Per cyl.)	Coussinets de bielle Conrod bearings (Par cyl. / Per cyl.)	Coussinets de palier Main bearings (Par palier / Per hub)	Epaisseurs latérales Thrust washers (Par mot. / Per engine)				
H.466, H.476, H.486 (4 cyl.)	066.0050.6 (A)	078.1451.0 Languette sans trou Strip less hole Ep. /Thick. : 1,2mm							
H.468, H.468.4, H.468 Prestige, H.476F, H.478, H.478 Prestige, H.488T, H.488 Prestige, H.775F, H.775V (4 cyl.)	089.0050.6 (A)					078.1452.0 Languette avec 2 trous Strip with 2 holes Ep. /Thick. : 1,4mm	065.1225K (2x 065.1225.0)	065.1216K (1x 065.1215.0 + 1x 065.1216.0)	065.1218K (4x 065.1218.0)
H.6115 Elite H.6135 Elite, H.6165 (6 cyl.)	337.0050.6 (A)					078.1453.0 Languette avec 1 trou Strip with 1 hole Ep. /Thick. : 1,6mm			
H.360 (3 cyl.)		057.1456.0							
H.470, H.480 (4 cyl.)	SLT.714/14254 (B)								
H.6130, H.6136, H.6160T, H.6170 (6 cyl.)	064.0050.6 (B) (057.0050.6)					062.1225K (2x 062.1225.0)	073.1215K (2x 029.1215.0)	042.1218K (2x 042.1218.0 + 2x 042.1219.0)	
H.490T, H.496T (4 cyl.)	SLT.714/14254 (B) (059.0050.6)								
H.5110T, H.5116T (5 cyl.)	058.0050.6 (B)								

Coussinets & épaisseurs latérales disponibles en côte réparation. / Bearings and thrust washers are available in oversize.

(A) Sans joint de culasse / Less cyl. head gasket

(B) Avec joint de culasse / With cyl. head gasket

Les références des pièces sont indicatives.

Nos pièces ne sont pas d'origine.

Part numbers are quoted for reference purposes only.

Our parts and accessories are not original.



PISTONS, JEUX DE SEGMENTS & CYLINDRES (REFROIDISSEMENT PAR AIR)
PISTONS, RING SETS & CYLINDERS (AIR COOLING)

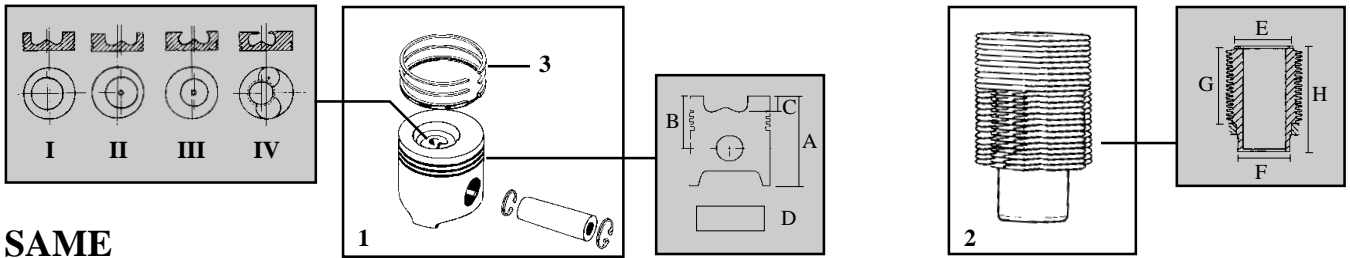

SAME

Figures			1	2	3
Tracteurs Tractors	Alésage Bore	Fig. Fig.	Pistons & segments Pistons & ring set	Cylindre Cylinder	Jeu de segments Ring set
Atlanta, Centauro, Delfino Minitauro (Mot. 953 Engine)	95				S.021/00526 (5 segments 5 rings set)
Sirenetta, Delfino 35, Aurora 45, Corsaro 70 Drago, Falcon Vigneron (Mot. 982, 983, 984, 986/L Engine) Solar 50	98	IV	S.303900 Ø Chambre Ø Chamber 55mm A : 120 B : 70 C : -22,50 D : 35x80	S.103900	E : 115 F : 117 G : 158 H : 223
Panther (Mot. 985/041 Engine), Drago			S.304350 Ø Chambre Ø Chamber 46,5mm		
Tiger Six 105, Panther 90, Corsaro 70SY Condor 55SY (Mot. 983, 984, 985, P-986P Engine)		III	S.305000 A : 119 B : 69 C : -21,60 D : 35x80	S.105000	E : 118,5 F : 114 G : 152 H : 217,5
Italia 35, Leone 70 (Mot. 1002V, 1004V Engine)	100	IV	S.303340 A : 125 B : 70 C : -22,40 D : 35x85	S.103340	E : 115 F : 112 G : 148 H : 231
Tiger Six (Mot. 1006P Engine), Condor, Solar C55, C554, (Mot. 1003P Engine), Corsaro 70 Synchro, Vigneron 70 (Mot.1004P Engine), Laser 110 (Mot.1006P Engine)			II		
Explorer 55 (Mot. 916.3.A Engine), Explorer 65/65C/65SP, Explorer 75C/75Exp./75SP (Mot. 916.4.A Engine)	103	III	S.304194 A : 100 B : 60 C : -20,30 D : 32x77	S.104194	E : 116 F : 112,8 G : 72 H : 194,5
Drago 120, Tiger 100, Leopard 85, Buffalo 130, Laser 100, Laser 130, Saturno 80SY, Trident 130, Centurion 75, Jaguar 95, Panther 95, Taurus (Mot. 1054, 1055, 1056/P Engine), Minitaurus, Mercury 85	105*120	I	S.304600 (Std./Std.) S.460/05 (Ø + 0,5) A : 119 B : 69 C : -21,80 D : 35x90	S.104600	E : 118,5 F : 114 G : 152 H : 217,5
Minitauro 60, Buffalo 120, Saturno 80 (Mot. 1052, 1053, 1054, 1055, 1056/L Engine)			IV		
Leopard 90, Laser 90 (Mot. 1054PT Engine) Hercules 160, Galaxy 170, Laser 150T (Mot. 1056PT Engine) (1979 ⇄)	105*120	III	S.304136 (Std./Std.) S.413/05 (Ø + 0,5) A : 119 B : 69 C : -24 D : 35x90	S.104136 ou/or S.104600	E : 124 F : 114 G : 152 H : 217,5

Pistons & segments disponibles en côte réparation +0.5 & +1.0. / Pistons & ring sets are available in oversize + 0.5 & 1.0.

Les références des pièces sont indicatives.
Nos pièces ne sont pas d'origine.

Part numbers are quoted for reference purposes only.
Our parts and accessories are not original.



PISTONS, JEUX DE SEGMENTS & CYLINDRES (REFROIDISSEMENT PAR AIR)
PISTONS, RING SETS & CYLINDERS (AIR COOLING)

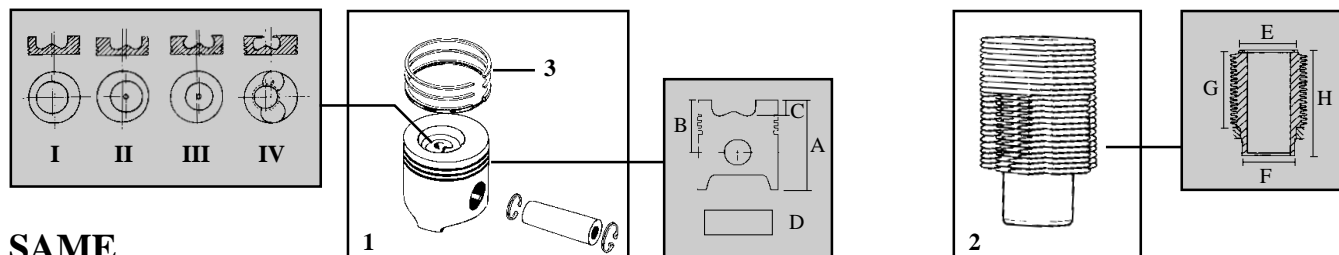

SAME

Figures			1	2	3	
Tracteurs Tractors	Alésage Bore	Fig. Fig.	Pistons & segments Pistons & ring set	Cylindre Cylinder	Jeu de segments Ring set	
Aster 60, Explorer 60/60SP/60II, Frutetto 60 Vigneron 62 (Mot. 1000-3A Engine) Explorer 70/70SP/70II/70C, Antares 110 Frutetto 75, Explorer 80SP/80II/80C (Mot. 1000-4A/4A1 Engine)	105*115,5	II	086.0060.6	S.104239 (0851120) ⇔ 26012	E : 116 F : 114,8 G : 72,5 H : 194,5	086.0052.6 (3 segments/3 rings set)
Antares 130 Silver 80, 90 Explorer II 90 (Mot. 1000-4AT Engine)			338.0060.6 Renforcé Heavy duty			
JOINT DE CYLINDRE CYLINDER GASKET			Cylindre/Cylinder		Réf./Ref.	Dimensions
			S.104239		2.1519.096.0	107,65x1,78
			S.070762		2.1539.130.0	117,07x3,53

LAMBORGHINI - HÜRLIMANN

Figures			1	2	3	
Tracteurs Tractors	Alésage Bore	Fig. Fig.	Pistons & segments Pistons & ring set	Cylindre Cylinder	Jeu de segments Ring set	
Lamborghini 235S, R.500, R.550, 654 C.362, C.453, C.533, C.352	98	IV	S.303900 (Std./Std.) A : 120 B : 70 C : -22,5 D : 35x80	S.103900	E : 115 F : 117 G : 158 H : 223	S.034/00526 (4 segments 4 rings set)
Hürliemann H.351, Mot. 982L, 983L Engine						
Lamborghini R.1056, R.754, R.654, R.550, R.483 R.1156		III	A : 119 B : 69 C : -21,60 D : 35x80	S.105000	E : 118,5 F : 114 G : 152 H : 218	
Lamborghini R.653, 784, 854, 955, 1256 R.754, C.754, R.1156, R.1056, R.1256, C.653	105*120	I	S.304600 (Std./Std.) S.460/05 (Ø + 0,5) A : 119 B : 69 C : -21,80 D : 35x90	S.104600	E : 118,5 F : 114 G : 152 H : 217,5	S.038/00526 (4 segments 4 rings set)
Hürliemann H361						
Lamborghini R.573-60N, R.574-60N, 600, 660F, 660V (Mot. 1000-3A Engine)	105*115,5	II	S.304239 (Std./Std.) A : 97,25 B : 57,25 C : -19,55 D : 35x86	S.104239	E : 116 F : 114,8 G : 72,5 H : 194,5	S.014/13952 (3 segments 3 rings set)
Hürliemann H306XE, H362, H361V, H361F, H361XF						

Les références des pièces sont indicatives.
Nos pièces ne sont pas d'origine.

Part numbers are quoted for reference purposes only.
Our parts and accessories are not original.

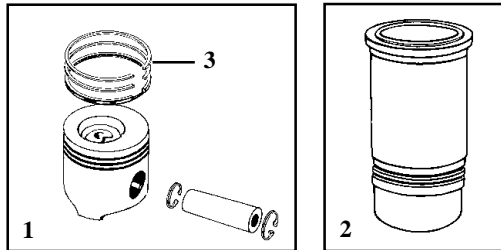

PISTONS, JEUX DE SEGMENTS & CHEMISES (REFROIDISSEMENT PAR EAU)
PISTONS, RING SETS & LINERS (WATER COOLING)
LAMBORGHINI

Figures			1	2	3
Tracteurs Tractors	Type de moteur Engine type	Alésage Bore	Piston et segments Piston & ring set	Chemise (Sans joints) Liner (Less gaskets)	Jeu de segments Ring set
R.674, R.674.5, C.674	916.4W (4 cyl.)	103	SLT.714/13301 (066.0060.6, 069.00600.6) Axe / Pin : 32x77mm	SLT.714/13302 (066.1120.0)	SLT.714/14252 (065.0052.6) (3 segments 3 rings set)
R.774, C.774, 774-5	916.4W/1 (4 cyl.)				
R.956, R.956-100	916.6W/1 (6 cyl.)				
R.1106	916.6W/2 (6 cyl.)				
R.1306	916.6WT (6 cyl.)		078.0060.6 Axe / Pin : 35x86mm		
R.674-70, R.674-70N, C.674-70 Grand-Prix	1000.4W (4 cyl.)	105	086.0060.6 Axe / Pin : 35x86mm	088.1120.0	086.0052.6 (3 segments 3 rings set)
R.774-80, R.774-80N, C.774-80, C.774-80 Grand-Prix	1000.4W1 (4 cyl.)				
C.874-70T, C.874-90T Grand-Prix	1000.4WT (4 cyl.)				
L.105	1000.4WTI (4 cyl.)				
L.115, Formula 115	1000.6W1 (6 cyl.)				
L.135, Formula 135	1000.6WTI (6 cyl.)		087.0060.6 Axe / Pin : 35x86mm		081.0090.6 (3 segments 3 rings set)
R.1506	1106/14T (6 cyl.)	110	064.0060.6 Axe / Pin : 40x93mm	057.1120.0	057.0051.6 (3 segments 3 rings set)
R.1706	1106/17T (6 cyl.)				

Les références des pièces sont indicatives.
 Nos pièces ne sont pas d'origine.

Part numbers are quoted for reference purposes only.
 Our parts and accessories are not original.



PISTONS, JEUX DE SEGMENTS & CHEMISES (REFROIDISSEMENT PAR EAU)
PISTONS, RING SETS & LINERS (WATER COOLING)

HÜRLIMANN

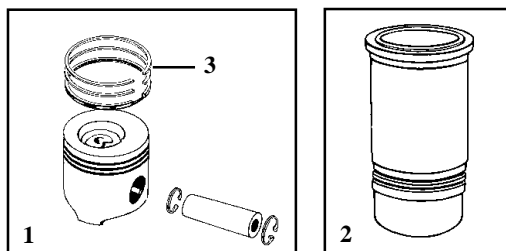

Figures			1	2	3
Tracteurs Tractors	Type de moteur Engine type	Alésage Bore	Piston et segments Piston & ring set	Chemise (Sans joints) Liner (Less gaskets)	Jeu de segments Ring set
H.356	916.3W	103	SLT.714/13301 (066.0060.6, 069.00600.6) Axe / Pin : 32x77mm	SLT.714/13302 (066.1120.0)	SLT.714/14252 (065.0052.6) (3 segments 3 rings set)
H.466, H.476	916.4W (4 cyl.)		078.0060.6 Axe / Pin : 35x86mm		
H.486	916.4WT (4 cyl.)				
H.468, H.468.4, H.468 Prestige, H.476F, H.775F, H.775V	1000.4W (4 cyl.)	105	086.0060.6 Axe / Pin : 35x86mm	088.1120.0	086.0052.6 (3 segments 3 rings set)
H.478, H.478 Prestige	1000.4W1 (4 cyl.)				
H.488T, H.488 Prestige	1000.4WT (4 cyl.)		087.0060.6 Axe / Pin : 35x86mm		
H.6115 Elite	1000.6W1 (6 cyl.)		086.0060.6 Axe / Pin : 35x86mm		
H.6135 Elite	1000.6WTI (6 cyl.)		087.0060.6 Axe / Pin : 35x86mm		
H.360	1103/5 (3 cyl.)	110	058.0060.06 Axe / Pin : 35x82mm	057.1120.0	057.0051.6 (3 segments 3 rings set)
H.470	1104/6 (4 cyl.)				
H.480	1104/7 (4 cyl.)				
H.6130	1106/12 (6 cyl.)				
H.6136	1106/13 (6 cyl.)				
H.6160T	1106/15 (6 cyl.)				
H.490T, H.496T	1104/8T (4 cyl.)		064.0060.6 Axe / Pin : 40x93mm		
H.5110T	1105/10T (5 cyl.)				
H.5116T	1105/11T (5 cyl.)				
H.6170	1106/17T (6 cyl.)				

Les références des pièces sont indicatives.
Nos pièces ne sont pas d'origine.

Part numbers are quoted for reference purposes only.
Our parts and accessories are not original.

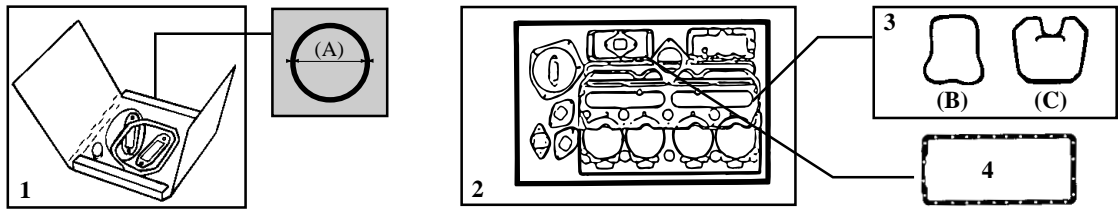

JOINTS DE MOTEUR (REFROIDISSEMENT PAR AIR)
ENGINE GASKET SETS (AIR COOLING)
SAME

Figures	1	2	3	4		
Tracteurs Tractors	Pochette rodage Top gasket set (Par cyl. / Per cyl.)	Pochette complète Full gasket set	Joint cache-soupapes Rocker cover gasket	Joint de carter Sump gasket		
Delfino 35, Fox 35, Vigneron (2 cyl.)	S.034/0057D (A) 99x114mm	29/A.31321 (034.0050.6)	S.029/1450 (B)	S.027/1512A		
Aurora 45, Fox 45/55, Vigneron 45 (3 cyl.)		29/A.31320 (035.0050.6)		S.029/1512B		
Condor 55 Syn., Minitaurus 60 Syn., Taurus 60 (3 cyl.)	S.054/0057G (A) 106x118mm	29/A.31327 (054.0050.6)	S.029/1450 (B)	S.00/54043		
Explorer 65, 75, 85 (Mot.916 A/A Engine, 4 cyl.)	S.065/0057K (A) 104x114mm	29/A.31328 (065.0050.6)			S.029/1455A (C)	S.00/54046
Centauro 70, Corsaro 70, Tiger Six Exp. (Mot. 984L Engine, 4 cyl.)	S.047/0057F (A) 103x117mm	29/A.31322 (045.0050.6)			S.029/1450 (B)	S.036/1512C
Centurion 75 Exp., Leopard 85 Exp., Mercury 85 Exp., Saturno 80 Syn. (Mot. 1054 Engine, 4 cyl.)	S.042/0057H (A) 106x118mm	29/A.31323 (044.0050.6)				
Centauro 75, Laser 90 (Mot. 1054 Engine, 4 cyl.)	S.080/0057N (A) 106x118mm	29/A.31329				
Jaguar 95 Exp., Panther 95, Laser 100, Tiger 100 (Mot. 1055 Engine, 5 cyl.)	S.042/0057H (A) 106x118mm	29/A.31326 (042.0050.6)				
Laser 110 (Mot. 1006/PA Engine, 6 cyl.) Tiger Six 105	S.072/0057L (A) 104x117mm	29/A.31330 (072.0050.6)				
Laser 130 (Mot. 1056/PA Engine, 6 cyl.)	S.073/0057M (A) 106x118mm	29/A.31331 (073.0050.6)				
Buffalo 130, Drago 120, Trident 130 (Mot. 1056/P Engine, 6 cyl.)	S.042/0057 (A) 106x118mm	29/A.32083				
Hercules 160	S.052/00576 (A) 106x118mm	S.052/00506				
Laser 150, Galaxy 170	S.071/00576 (A) 107x124x2,5mm	S.071/00506				
Sametto, Italia 32, Atlanta 42, Centauro 55	S.021/0057A (A) 97x108mm					
Sirenetta, Delfino 32, Minitauro 46, 50, 55	S.029/0057C (A) 97x110mm					
Panther 88	S.041/0057E (A) 99x114mm					
Italia 35, Sametto, Leone, Atlanta 45	S.024/0057B (A) 102x114mm					
Minitauro 60, Saturno 80, Buffalo 120	S.038/0057K (A) 107x121mm					

 Les références des pièces sont indicatives.
 Nos pièces ne sont pas d'origine.

 Part numbers are quoted for reference purposes only.
 Our parts and accessories are not original.

JOINTS DE MOTEUR (REFROIDISSEMENT PAR AIR)
ENGINE GASKET SETS (AIR COOLING)

LAMBORGHINI

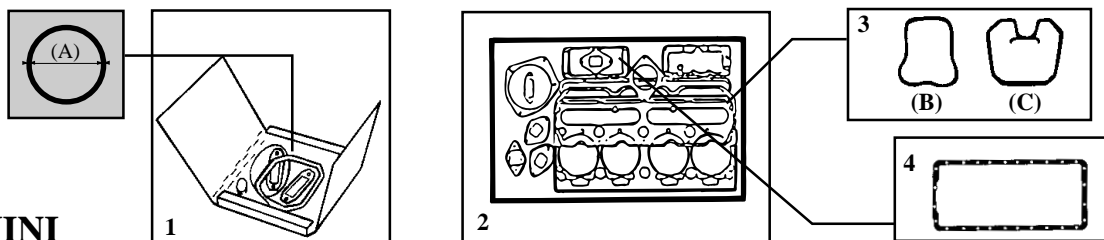

Figures	1	2	3	4
Tracteurs Tractors	Pochette rodage Top gasket set (Par cyl. / Per cyl.)	Pochette complète Full gasket set	Joint cache-soupapes Rocker cover gasket	Joint de carter Sump gasket
R.235, R.235DT, C.352 (2 cyl.)	S.034/0057D 99x114mm (A)	29/A.31321 (034.0050.6)	S.029/1450 (B)	S.027/1512A
R.653, C.653 (3 cyl.)	S.054/0057G 106x118mm (A)	29/A.31327 (054.0050.6)		S.029/1512B
R.654, R.754 (4 cyl.)	S.047/0057F 103x117mm (A)	29/A.31322 (045.0050.6)		S.036/1512C
R.784, R.784DT (4 cyl.)	S.072/0057L 104x117mm (A)			
754, 754DT, 854DT (4 cyl.)	S.042/0057H 106x118mm (A)	29/A.31323 (044.0050.6)		
955, 1055 (5 cyl.)		29/A.31326 (042.0050.6)		S.041/1512D

Les références des pièces sont indicatives.
Nos pièces ne sont pas d'origine.

Part numbers are quoted for reference purposes only.
Our parts and accessories are not original.



POMPES D'ALIMENTATION & KITS DE REPARATION
FUEL PUMPS & REPAIR KITS

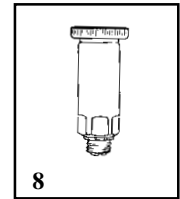
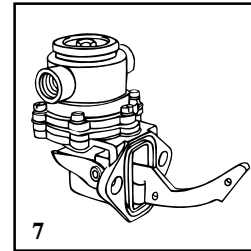
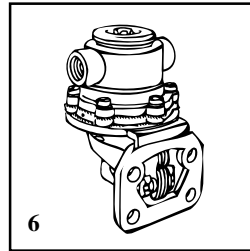
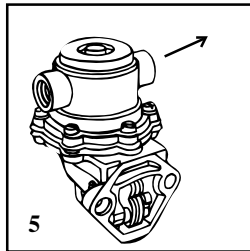
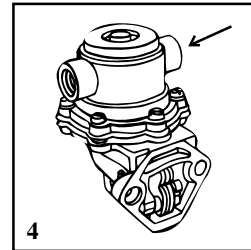
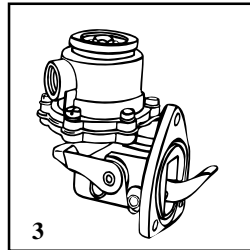
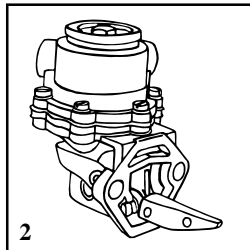
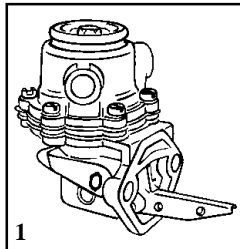

SAME

Tracteurs Tractors	Fig. Fig.	Référence Reference	OEM	Kit réparation Repair kit	OEM
Atlanta, Centauro, Leone	1	S.4519/010 Filet./Thread : 10x1	245190100	S.390K	24519139
	2	S.4519/130 Filet./Thread : 14x,5	245191300	S.390K	24519239
Samitalia, Sametto	3	S.4519/020		S.341K	24519019
Aurora, Corsaro, Centurion 75, Delfino Falcon, Minitauro, Saturno, Sirenetta	4	S.4519/100	00383196 245191600 245191900	S.298K	24519189
Buffalo, Corsaro, Drago, Leopard Minitauro, Panther, Saturno, Tiger	5	S.4519/140	245191400 245191500 245191800 245192000	S.400K	24519129
Buffalo 130, 140, Drago 120, Centurion, Condor, Corsaro 70, Jaguar 95, Mercury, Minitaurus, Panther 90, Saturno 80, Taurus, Tiger 100, 105, Leopard 85, 90 Laser 90, 100, 110, 130, 150 Minitauro 60 synchro	6	S.4519/230	245192200 245192300 245192900	S.4519/239	24519239
Antares 110, 130, Aster 60, Explorer, Silver, Titan, Frutteto 60	7	S.4519/280	245193000	S.4519/269	24519269
Drago	8	S.2212			
6 cylindres & industriels 6 cylinders & industrials	7	S.4519/310	245193100		

Pour d'autres types de tracteurs, se référer aux figures de ce programme
For other models, check the pictures

Les références des pièces sont indicatives.
Nos pièces ne sont pas d'origine.

Part numbers are quoted for reference purposes only.
Our parts and accessories are not original.



POMPES D'ALIMENTATION & KITS DE REPARATION
FUEL PUMPS & REPAIR KITS

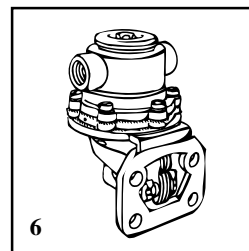
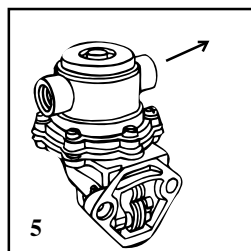
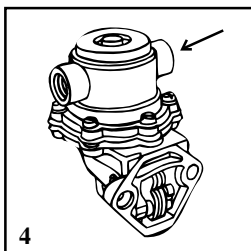
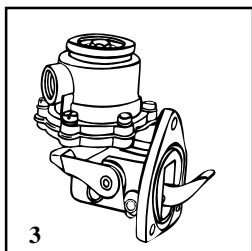

LAMBORGHINI

Tracteurs Tractors	Fig. Fig.	Référence Reference	OEM	Kit réparation Repair kit	OEM
Anciens montages / Previous fittings	3	S.4519/020		S.341K	24519019
553, 653, 753, 854, 654	4	S.4519/100	00383196 245191600 245191900	S.298K	24519189
R.1056 (⇄ 1979)	5	S.4519/140	245191400 245191500 245191800 245192000	S.400K	24519129
1056, 653, R.854, R.754	6	S.4519/230	245192200 245192300 245192900	S.4519/239	24519239

HÜRLIMANN

Tracteurs Tractors	Fig. Fig.	Référence Reference	OEM	Kit de réparation Repair kit	OEM
H.6160	6	S.4519/230	245192200 245192300 245192900	S.4519/239	24519239

Pour d'autres types de tracteurs, se référer aux figures de ce programme
For other models, check the pictures

Les références des pièces sont indicatives.
Nos pièces ne sont pas d'origine.

Part numbers are quoted for reference purposes only.
Our parts and accessories are not original.



BOUGIES DE PRECHAUFFAGE
HEATER PLUGS

SAME

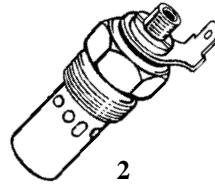
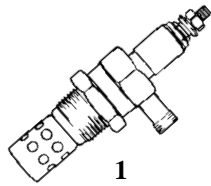

Tracteurs Tractors	Fig. Fig.	Réf. Ref.	Filetage Thread	Volts Volts	Ampères Amperes
Equipement "BOSCH" <i>Equipment</i>	1	S.7659/013	M20x1,5	9,5	22
Equipement "CAV" <i>Equipment</i>	2	S.7659/007	1/2" BSP	12	12,5

NEZ D'INJECTEURS
INJECTOR NOZZLES

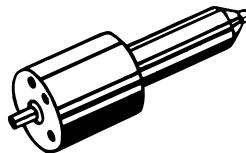

SAME

Tracteurs Tractors	Référence Reference	N° sur injecteur N° on the nozzle
Buffalo 130, Centurion 70, Corsaro, Faleon, Condor 55, Delfino 35, Leopard, Jaguar, Laser 90 ↔ 130, Minitauro, Minitaurus	29/71095 (247290100)	433271079 DLLA160S255
Drago 100, Saturno, Buffalo 120, Corsaro	29/71233 (247290500)	DLLA160S608
Laser 150, Galaxy 170, Hercules 160	29/4729-090 (247290900)	DLLA150S830
Explorer 60, 70, 75, 80, 90, Aster 60, Frutteto 60, 75, Vigneron 62, 75, Antares 110, 130, Silver	29/4729-100 (247291000)	DDLA150S925 DLLA150S690

LAMBORGHINI

R.235, 653, 854, 754, 455, 1056DT, 1256DT	29/71095 (247290100)	433271079 DLLA160S255
674-70, 874-90, 774-80, 600, 700, 1106, 1306, 105, 775F	29/4729-100 (247291000)	DDLA150S925 DLLA150S690

HÜRLIMANN

Selon applications <i>Some applications</i>	29/71199 (247290800)	433271855 DLLA150S806
H.351, H.361	29/71095 (247290100)	433271079 DLLA160S255
H.358, 362, 468, 478, 488T, 4105	29/4729-100	DDLA150S925 DLLA150S690

Les références des pièces sont indicatives.
Nos pièces ne sont pas d'origine.

Part numbers are quoted for reference purposes only.
Our parts and accessories are not original.

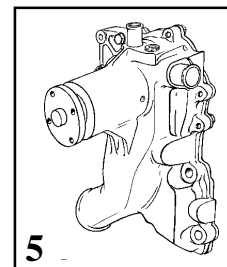
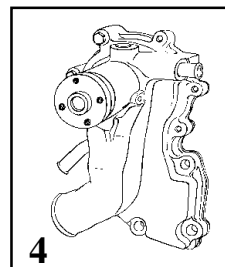
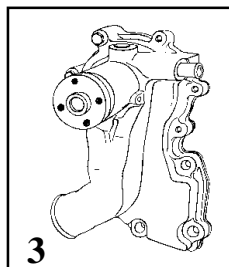
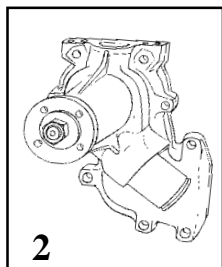
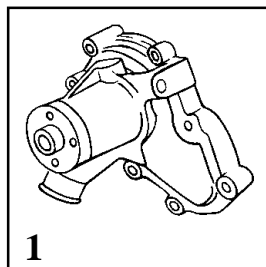

POMPES A EAU
WATER PUMPS

SAME

Tracteurs Tractors	Fig. Fig.	OEM	Pompe Pump
Silver 80, 90, 100.4	1	08217404 / 10-20-30-40-50 08217406	082.1740.450 (B) 3 sorties + Trou fileté 3 outlets + threaded hole
Titan 145, 160, 190	2	0641740620	064.1740.620 (B)
Silver 100.6	3	0751740450 07517404/60	075.1740.450 (B)
Antares II, 110, 130	4	0781740450 07817404/60	078.1740.450 (B)

LAMBORGHINI

Tracteurs Tractors	Fig. Fig.	OEM	Pompe Pump
674, 674.70, 674.70GP, 774.5 Sprint 664.60, 664.70, 774.80 Cross 574.60, 674.70 Plus 660, 775, 880, 990 Vigneto 660, 775	1	06617404 / 10-20-30-40-50-60 00970396	066.1740.460 (B) 2 sorties / 2 outlets
774.80, 774.80GP, 775, 874.90, 874.90GP Premium 850, 950, 1050 Formula 105		08217404 / 10-20-30-40-50 08217406	082.1740.450 (B) 3 sorties + Trou fileté 3 outlets + threaded hole
874-90 avec airco / With airco		08217564	082.1756.4 (B) 4 sorties / 4 outlets
1106, 1306, 1356, 1556, 1506, 1706 Racing 150, 165, 190	2	0641740620	064.1740.620 (B)
956, 1306, 1060 Formula 115, 135	3	0751740450 07517404/60	075.1740.450 (B)
1106, 1306	4	0781740450 07817404/60	078.1740.450 (B)
Formula 115-135, Premium 1060, Racing 150, 165, 190	5	00705954/30 01011384/20	010.1138.4 (B)

(B) Sans poulie / Less pulley

 Les références des pièces sont indicatives.
 Nos pièces ne sont pas d'origine.

 Part numbers are quoted for reference purposes only.
 Our parts and accessories are not original.

POMPES A EAU
WATER PUMPS

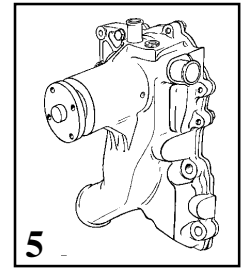
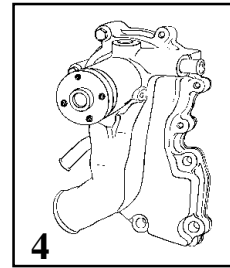
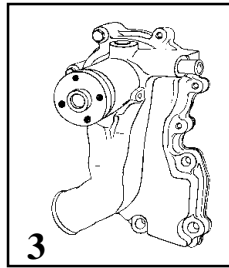
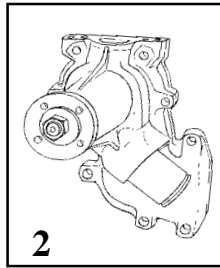
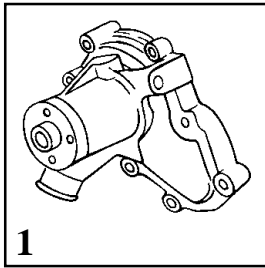

HÜRLIMANN

Tracteurs Tractors	Fig. Fig.	OEM	Pompe Pump
H.356, H.358	1	06617404 / 10-20-30-40-50-60 00970396	066.1740.460 (B) 2 sorties / 2 outlets
Club H358.4, H468.4		08217404 / 10-20-30-40-50 08217406	082.1740.450 (B) 3 sorties + Trou fileté 3 outlets + threaded hole
488T, XA606, XA607, XT908, XT909, XT910.4		08217564 08217406	082.1756.4 (B) 4 sorties / 4 outlets
360, 470, 480, 490, 5110, 6130, H.5110T, 6136, 496T, 5116T, 6170T, 6165, 6190	2	0641740620	064.1740.620 (B)
Elite 6115, 6135, XT908, XT909, XT910.4	3	0751740450 07517404/60	075.1740.450 (B)
XT910.6	4	0781740450 07817404/60	078.1740.450 (B)
H.6115, H.6135 Elite, Master H.6165, 6190	5	00705954/30 01011384/20	010.1138.4 (B)

(B) Sans poulie / Less pulley

Les références des pièces sont indicatives.
Nos pièces ne sont pas d'origine.

Part numbers are quoted for reference purposes only.
Our parts and accessories are not original.



COURROIES DE VENTILATEUR
FAN BELTS

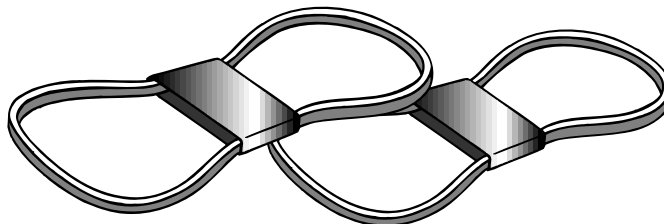

SAME

Tracteurs <i>Tractors</i>	Réf. par pair <i>Ref. by pair</i>	OEM
Corsaro 70, Minitauro 60	S.4119/001 2x(AVX10-1400)	241190010, 241190360, 241190610
Aurora, Delfino, Minitauro 50, Vigneron 35, 45, 50 Falcon, Solar 50, Saturno 80, Explorer 65, 70, 75, 80	S.4119/007 2x(AVX10-1350)	241190070, 241190510 244190740
Buffalo 120, Drago 100	S.4119/034 2x(AVX10-1525)	241190340
Buffalo 130, Jaguar 95, 100, Tiger 100, 105, Drago 120 Panther 90, Laser 110, 130	S.4119/040 2x(AVX10-1550)	241190400 241190860
Centaurio 70, Leopard 85, 90, Mercury 85, Saturno 80, Centurion 75	S.4119/053 2x(AVX10-1450)	241190530, 241190420, 241190760
Hercules 160, Panther 88, 95 Tiger 105 (↔ 8469), Trident 130, Laser 100	S.4119/054 2x(AVX10-1575)	241190540, 241190390 241190500, 241190770
Minitauro 55	S.4119/066 2x(AVX10-1375)	241190660, 241190120
Corsaro 70, Condor 55, Minitaurus, Solar 60 Taurus 60, Vigneron 60	S.4119/075 2x(AVX10-1425)	241190750, 241190410 241190460, 241190520
Titan 145, 160, Antares 110, 130	S.4119/118 2x(AVX13-1450)	041191180

LAMBORGHINI

Tracteurs <i>Tractors</i>	Réf. <i>Ref.</i>
360, 360DT	AVX13-1325
483, 503, 503S, 503DT, 583, 603, 603DT	AVX10-1150
704, 704DT, 804, 804DT, 904, 904DT	AVX13-1275
550, 660, 654, 754, 784, 854	AVX10-1475
674, 774, 874	AVX10-1225
955, 1056, 1156, 1256	AVX10-1500
1356, 1556	AVX10-1625
653, 683, 684	AVX10-1425
956	AVX13-1300
1106	AVX13-1425
1306	AVX13-1350
1506, 1706	AVX10-1575

HÜRLIMANN



Tracteurs <i>Tractors</i>	Réf. <i>Ref.</i>
H5110T, H5116T, H6130, H6136 6160 (↔ 20400221)	AVX10-1625
6160 (20400222 ↔), H6170T	AVX10-1575
H345	AVX10-1350
H355F	AVX10-1425
H356 mot. / engine 916.3 (↔ 1110)	AVX10-1225
H356 mot. / engine 916.3 (1111 ↔)	AVX10-1200
H466, H466-4, mot. / engine 916-4	AVX10-1225
H470, H480, H490	AVX10-1400

Les références des pièces sont indicatives.
Nos pièces ne sont pas d'origine.

Part numbers are quoted for reference purposes only.
Our parts and accessories are not original.

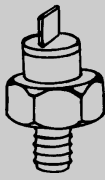
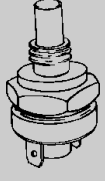

CONTACTEURS DIVERS
SWITCHES (MISCELLANEOUS)

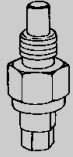
S.7099/040 (70990100)	Huile (Fil. 10x1)(↔ 50ps) <i>Oil (Thread : 10x1)</i>	
S.7099/1205 (70790400/10)	Huile (Fil. 12x1,75)(50ps ↔) <i>Oil (Thread : 12x1,75)</i>	
S.7099/180 (270991800)	Prise de force <i>PTO drive</i>	
S.7099/190 (270991900)	Hydraulique stop <i>Hydraulic stop</i>	
S.7099/320 (27099320)	Colmatage filtre à air <i>Plugging of air filter</i>	
29/7659.008 (27659008)	Sécurité, ouvert, 2 plots <i>Safety, open, 2 plugs</i>	
S.7659/021 (276590210/01)	Sécurité, ouvert, 4 plots <i>Safety, open, 4 plugs</i>	
S.7659/0140 (27659014/01)	Sécurité, fermé <i>Safety, closed</i>	
S.7659/05 (276590050)	Position/contact/démarrage 5 plots <i>Position/switch/starter</i> 5 plugs	
S.7659/6 (276590060/01)	Préchauffage/contact/démarrage 7 plots <i>Heating/switch/starter</i> 7 plugs	
S.7659/12 (276590240)	Préchauffage/contact/démarrage 8 plots <i>Heating/switch/starter</i> 8 plugs	
S.7069/040 (270690400/01)	Contacteur de température <i>Temperature switch</i> Same Buffalo, Drago	

JAUGES DE RESERVOIR
SENDER UNIT

Types sans réserve / *Types less reserve*

- S.7059/800** Lg. : 390mm
- S.7059/130** Lg. : 455mm
- S.7059/100** Lg. : 295mm
- S.7059/120** Lg. : 428mm
- S.7059/022** Lg. : 480mm

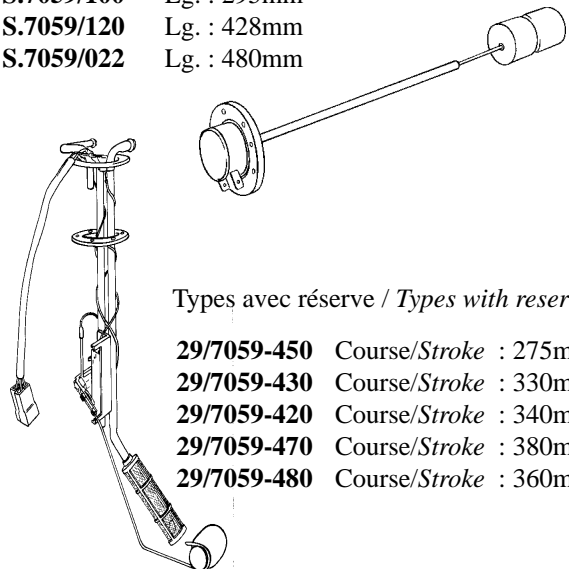

Types avec réserve / *Types with reserve*

- 29/7059-450** Course/Stroke : 275mm
- 29/7059-430** Course/Stroke : 330mm
- 29/7059-420** Course/Stroke : 340mm
- 29/7059-470** Course/Stroke : 380mm
- 29/7059-480** Course/Stroke : 360mm

Les références des pièces sont indicatives.
Nos pièces ne sont pas d'origine.

Part numbers are quoted for reference purposes only.
Our parts and accessories are not original.

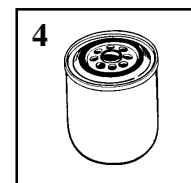
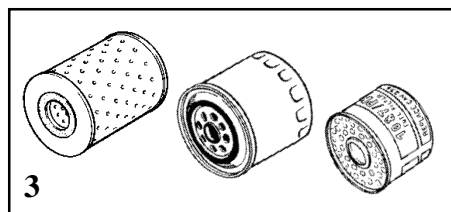
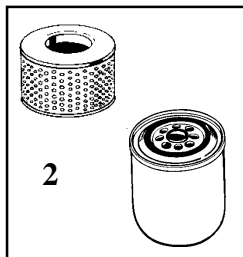
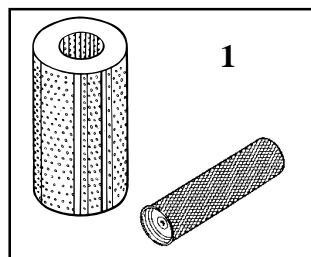

FILTRATION - SAME
FILTERS - SAME

Tracteurs Tractors	1		2	3	4
	Ext. / Out.	Int. / Inn.	Huile Oil	Combustible Fuel	Hydraulique Hydraulic
Antares 100 Syncro	60/161-104 (TFA.581)	60/162-25 (2466)	60/97-38 (309/F)	60/111-4 (1193/F) (Repl. CAV 796)	60/240-69 Ht.: 180mm Filet / Thread M40x2 ou / or 60/240-68 Ht.: 186mm Filet / Thread 1"1/8
Antares 110 Moteur A6 110HP Engine					
Antares 130 Turbo Moteur AT 127HP Engine					
Atlanta, Samecar 42, Samecar 45			60/96-3 (102T)	60/111-64 (F.1007) + 60/111-32 (1007)	
Argon 50, 60, Crono 50, 60			60/97-36 (294/F)	60/111-25 (5006/F) (Repl. CAV 496)	
Argon 70, Crono 70	60/161-104 (TFA.581)	60/162-25 (2466)	60/97-22 (169)	60/111-16 (1194/F)	
Ariete 137			60/96-19 (109) (Cartouche Cartridge) ou / or 60/97-4 (305/F) (A visser / Spin on)	60/111-65 (F.1008) + 60/111-33 (1008)	
Aster 60	60/161-112 (TM.254) (Conique, vis centrale Conical type, central nut)	60/162-112 (TM.255)	60/97-36 (294/F)	60/111-3 (1087/PK) (Repl. CAV 296)	60/240-66 (SLT.4419/280) Ht.: 232mm Filet / Thread M40x2
Aster 70 Turbo Moteur 1000-3AT Engine	60/161-104 (TFA.581)	60/162-25 (2466)	60/97-22 (169)		
Aurora 45 (2RM / WD), Aurora 45 (4RM / WD) Vigneto	60/161-63 (2500)	60/162-1 (568)	60/97-2 (599AR/F)		

Les références des pièces sont indicatives.
Nos pièces ne sont pas d'origine.

Part numbers are quoted for reference purposes only.
Our parts and accessories are not original.



"THE RELIABLE SERVICE"



Tracteurs Tractors	1		2	3	4
	Air		Huile Oil	Combustible Fuel	Hydraulique Hydraulic
	Ext. / Out.	Int. / Inn.			
Buffalo 120 (2RM / WD), 120 (4RM / WD), 130 (4RM / WD)	60/161-60 (2465) Couvercle / Cap Ø 155mm (↔ 9/81)	60/162-25 (2466)	60/97-40 (332/F)	60/111-3 (1087/PK) (Repl. CAV 296) ou / or 60/111-4 (1193/F) (Repl. CAV 796)	
	60/161-104 (TFA.581) Couvercle / Cap Ø 214mm (9/81 ↔)	60/162-25 (2466)			
Buffalo 130, Buffalo 130 Export	60/161-60 (2465) Couvercle / Cap Ø 200mm (↔ Série / Serie 5960)	60/162-25 (2466)	60/97-38 (309/F)	60/111-4 (1193/F) (Repl. CAV 796)	
	60/161-104 (TFA.581) Couvercle / Cap Ø 214mm (Série / Serie 5961 ↔)	60/162-25 (2466)			
Centauro 60, Centauro 65	60/161-54 (2127) (Sans ailettes Less fins)		60/97-25 (370) (Filet / Thread 22x1,5) (↔ 15807) 60/96-3 (102T) (Cartouche Cartridge) ou / or 60/97-2 (599AR/F) (A visser / Spin on)	60/111-64 (F.1007) + 60/111-32 (1007) ou / or 60/111-3 (1087/PK) (Repl. CAV 296)	
Centauro 70 Export	60/161-112 (TM.254)	60/162-112 (TM.255)			60/240-67 (SLT.4419/320) Ht.: 264mm Filet / Thread M40x2
Centauro 70 Syncro	60/161-66 (7293) (Conique, 2 pattes Conical type, 2 fixings holes) (↔ 12/82)	60/162-66 (7285)	60/97-36 (294/F)	60/111-3 (1087/PK) (Repl. CAV 296)	60/240-66 (SLT.4419/280) Ht.: 232mm Filet / Thread M40x2
	60/161-112 (TM.254) (Conique, vis centrale Conical type, central nut) (1/83 ↔)	60/162-112 (TM.255)			

Les références des pièces sont indicatives.
Nos pièces ne sont pas d'origine.

Part numbers are quoted for reference purposes only.
Our parts and accessories are not original.



"THE RELIABLE SERVICE"



Tracteurs Tractors	1		2	3	4
	Air		Huile Oil	Combustible Fuel	Hydraulique Hydraulic
	Ext. / Out.	Int. / Inn.			
Centurion 75	60/161-59 (2449) (↔ Série / Serie 2870) 60/161-66 (7293) (Conique, 2 pattes Conical type, 2 fixings holes) (Série / Serie 2871 ↔ 5000) 60/161-112 (TM.254) (Conique, vis centrale Conical type, central nut) (Série / Serie 5001 ↔)	60/162-59 (2464) 60/162-66 (7285) 60/162-112 (TM.255)			
Centurion 75 Export	60/161-66 (7293) (Conique, 2 pattes Conical type, 2 fixings holes) (↔ 12/82) 60/161-112 (TM.254) (Conique, vis centrale Conical type, central nut) (1/83 ↔)	60/162-66 (7285) 60/162-112 (TM.255)	60/97-36 (294/F)	60/111-3 (1087/PK) (Repl. CAV 296)	60/240-67 (SLT.4419/320) Ht.: 264mm Filet / Thread M40x2 (↔ Série / Serie 5000) 60/240-66 (SLT.4419/280) Ht.: 232mm Filet / Thread M40x2 (Série / Serie 5001 ↔)
Centurion 75 Special	60/161-112 (TM.254)	60/162-112 (TM.255)			60/240-66 (SLT.4419/280) Ht.: 232mm Filet / Thread M40x2
Condor C	60/161-8 (2543)	60/162-8 (2544)			Filet / Thread M40x2
Condor 55, Condor 55 Syncro	60/161-8 (2543) (↔ Série / Serie 12000) 60/161-112 (TM.254) (Conique, vis centrale Conical type, central nut) (Série / Serie 12001 ↔)	60/162-8 (2544) 60/162-112 (TM.255)			

Les références des pièces sont indicatives.
Nos pièces ne sont pas d'origine.

Part numbers are quoted for reference purposes only.
Our parts and accessories are not original.



"THE RELIABLE SERVICE"



Tracteurs Tractors	1		2	3	4
	Air		Huile Oil	Combustible Fuel	Hydraulique Hydraulic
Ext. / Out.	Int. / Inn.				
Corsaro 60, 70 (2RM / WD), 70 (4RM / WD)	60/161-54 (2127) (Sans ailettes <i>Less fins</i>) (↔ Série / Serie 10122)		60/97-36 (294/F)		
	60/161-62 (2498) (Série / Serie 10123 ↔)	60/162-62 (2499)			
	ou / or				
	60/161-112 (TM.254) (Conique, vis centrale <i>Conical type, central nut</i>)	60/162-112 (TM.255)			
Corsaro 70 Syncro, DT	60/161-62 (2498)	60/162-62 (2499)			
Corsaro 70 Frutteto	60/161-66 (7293) (Conique 2 pattes <i>Conical type 2 fixings holes</i>) (↔ 12/82)	60/162-66 (7285)		60/111-3 (1087/PK) (Repl. CAV 296)	60/240-68 (SLT.4419/270) Ht.: 186mm Filet / Thread 1 1/8"
	60/161-112 (TM.254) (Conique, vis centrale <i>Conical type, central nut</i>) (1/83 ↔)	60/162-112 (TM.255)			
Delfino 32	60/161-87 (2477)		60/96-24 (101/F)		
Delfino 32 (2RM / WD), 32 (4RM / WD) Frutteto					
Delfino 32 Speciale			60/97-4 (305/F)		
Delfino 35 (4RM / WD), 35 (4RM / WD) Frutteto	60/161-63 (2500)	60/162-1 (568)			
Delfino 35 Deserto	60/161-8 (2543)	60/162-8 (2544)			
Dinosauro, Elefante TS/TS/W, TSA			60/96-19 (109)	60/111-65 (F.1008) + 60/111-33 (1008)	

Les références des pièces sont indicatives.
Nos pièces ne sont pas d'origine.

Part numbers are quoted for reference purposes only.
Our parts and accessories are not original.



"THE RELIABLE SERVICE"



Tracteurs Tractors	1		2	3	4		
	Air		Huile Oil	Combustible Fuel	Hydraulique Hydraulic		
	Ext. / Out.	Int. / Inn.					
Dorado 60 Moteur 1003A 60HP Engine			60/97-36 (294/F)	60/111-3 (1087/PK) (Repl. CAV 296)	60/240-69 (SLT.4419/350) Ht.: 180mm Filet / Thread M40x2		
Dorado 70 Moteur 1004A 70HP Engine							
Drago 100	60/161-59 (2449) Ø 134mm (↔ Série / Serie 5347) 60/161-60 (2465) Ø 155mm (Série / Serie 5348 ↔)	60/162-59 (2464) 60/162-25 (2466)	60/97-40 (332/F) (↔ 12/75) 60/97-38 (309/F) (1/76 ↔)				
Drago 120	60/161-60 (2465) Couvercle / Cap Ø 155mm (↔ Série / Serie 10604) 60/161-104 (TFA.581) Couvercle / Cap Ø 214mm (Série / Serie 10605 ↔)	60/162-25 (2466) 60/162-25 (2466)	60/97-38 (309/F)	60/111-4 (1193/F) (Repl. CAV 796)			
Explorer 55, 65, 75	60/161-112 (TM.254) (Conique, vis centrale Conical type, central nut)	60/162-112 (TM.255)	60/97-36 (294/F)	60/111-3 (1087/PK) (Repl. CAV 296)	60/240-69 (SLT.4419/350) Ht.: 180mm Filet / Thread M40x2		
Explorer 55 Export, Explorer 65 Export, Special							
Explorer 60, Explorer 60 II, Explorer 60 Special, Explorer 75							
Explorer 60 Frutteto, 75 Frutetto							
Explorer 60DT							
Explorer 65C Ergomatic, Explorer 70C Ergomatic, Explorer 75C Ergomatic						60/240-67 (SLT.4419/320) Ht.: 264mm Filet / Thread M40x2	
Explorer 70, Explorer 70C Special, Explorer 70 II							
Explorer 70C, 80C, 90C							
Explorer 75, Export, Special, Explorer 85, Export, Special							60/240-66 (SLT.4419/280) Ht.: 232mm Filet / Thread M40x2
Explorer 80 II, Explorer 80 Special, Explorer 80 Special Basso, Explorer 80C Ergomatic					60/161-104 (TFA.581)	60/162-25 (2466)	
Explorer 90 Turbo, Explorer 90 II Turbo			60/97-22 (169)	60/111-4 (1193/F) (Repl. CAV 796)			

Les références des pièces sont indicatives.
Nos pièces ne sont pas d'origine.

Part numbers are quoted for reference purposes only.
Our parts and accessories are not original.



"THE RELIABLE SERVICE"



Tracteurs Tractors	1		2	3	4
	Air		Huile Oil	Combustible Fuel	Hydraulique Hydraulic
	Ext. / Out.	Int. / Inn.			
Falcon C	60/161-8 (2543)	60/162-8 (2544)	60/97-2 (599AR/F) (↔ 12/75) 60/97-36 (294/F) (1/76 ↔)	60/111-3 (1087/PK) (Repl. CAV 296)	
Falcon (2RM / WD), (4RM / WD)	60/161-63 (2500) Ht.: 235mm (↔ Série / Serie 7209) 60/161-8 (2543) Ht.: 315mm (Série / Serie 7210 ↔)	60/162-1 (568) 60/162-8 (2544)	60/97-2 (599AR/F)		
Falcon CC, Falcon CL, Falcon CN	60/161-8 (2543)	60/162-8 (2544)			
Falcon 50					
Fox 35, Fox 45, Fox 55			60/97-4 (305/F)		
Frutteto 60			60/97-36 (294/F)		60/240-69 (SLT.4419/350) Ht.: 180mm Filet / Thread M40x2
Galaxy 170, Galaxy 170 Turbo					
Hercules 160 Export	60/161-64 (2553)	60/162-64 (TFA.734)	60/97-21 (121)	60/111-4 (1193/F) (Repl. CAV 796)	60/240-65 (SLT.4419/260) Ht.: 211mm Filet / Thread 1"
Italia V, VDT, Italia 35			60/96-24 (101/F)	60/111-28 (1009) (↔ Série / Serie 6495) 60/111-3 (1087/PK) (Repl. CAV 296) (Série / Serie 6496 ↔)	
Jaguar 95	60/161-60 (2465) Couvercle / Cap Ø 155mm (↔ 8/81) 60/161-104 (TFA.581) Couvercle / Cap Ø 214mm (9/81 ↔)	60/162-25 (2466) 60/162-25 (2466)	60/97-38 (309/F)	60/111-4 (1193/F) (Repl. CAV 796)	
Jaguar 95 Export	60/161-104 (TFA.581)	60/162-25 (2466)			60/240-65 (SLT.4419/260) Ht.: 211mm Filet / Thread 1"

Les références des pièces sont indicatives.
Nos pièces ne sont pas d'origine.

Part numbers are quoted for reference purposes only.
Our parts and accessories are not original.



"THE RELIABLE SERVICE"



Tracteurs Tractors	1		2	3	4
	Air		Huile Oil	Combustible Fuel	Hydraulique Hydraulic
	Ext. / Out.	Int. / Inn.			
Laser 90	60/161-104 (TFA.581)	60/162-25 (2466)	60/97-22 (169)	60/111-4 (1193/F) (Repl. CAV 796)	60/240-66 (SLT.4419/280) Ht.: 232mm Filet / Thread M40x2
Laser 100, Laser 110, Laser 130			60/97-38 (309/F)		
Laser 150, Laser 150 Turbo	60/161-64 (2553)	60/162-64 (TFA.734)	60/97-21 (121)		
Leopard C			60/97-36 (294/F)	60/111-3 (1087/PK) (Repl. CAV 296)	60/240-69 (SLT.4419/350) Ht.: 180mm Filet / Thread M40x2
Leopard 85, Leopard 85 Export	60/161-59 (2449)	60/162-59 (2464)			
Leopard 90 Turbo	60/161-104 (TFA.581)	60/162-25 (2466)	60/97-22 (169)	60/111-4 (1193/F) (Repl. CAV 796)	60/240-65 (SLT.4419/260) Ht.: 211mm Filet / Thread 1"
Mercury 85 Export, Mercury 85 Special	60/161-66 (7293) (Conique, 2 pattes Conical type, 2 fixings holes) (↔ 12/82)	60/162-66 (7285)	60/97-36 (294/F)	60/111-3 (1087/PK) (Repl. CAV 296)	60/240-65 (SLT.4419/260) Ht.: 211mm Filet / Thread 1" (85 Export)
	60/161-112 (TM.254) (Conique, vis centrale Conical type, central nut) (1/83 ↔)	60/162-112 (TM.255)			60/240-66 (SLT.4419/280) Ht.: 232mm Filet / Thread M40x2 (85 Special)
Minitauro C			60/97-2 (599AR/F)	60/111-3 (1087/PK) (Repl. CAV 296)	
Minitauro 55, Leone 70, Leone 75	60/161-54 (2127) (Sans ailettes Less fins)		60/96-3 (102T) (Cartouche Cartridge) ou / or 60/97-2 (599AR/F) (A visser / Spin on)	60/111-64 (F.1007) + 60/111-32 (1007) ou / or 60/111-3 (1087/PK) (Repl. CAV 296)	
Minitauro 60, Minitauro 60 Frutteto	60/161-62 (2498)	60/162-62 (2499)	60/97-2 (599AR/F)		
Minitauro 60 Syncro					60/240-64 (SLT.4419/250) Ht.: 143mm Filet / Thread 1"
Minitauro 60, 60 Syncro, Minitauro C			60/97-36 (294/F)	60/111-3 (1087/PK) (Repl. CAV 296)	
Minitauro, Frutteto	60/161-112 (TM.254)	60/162-112 (TM.255)			

Les références des pièces sont indicatives.
Nos pièces ne sont pas d'origine.

Part numbers are quoted for reference purposes only.
Our parts and accessories are not original.



"THE RELIABLE SERVICE"



Tracteurs Tractors	1		2	3	4
	Air		Huile Oil	Combustible Fuel	Hydraulique Hydraulic
Ext. / Out.	Int. / Inn.				
Panther 88	60/161-59 (2449)	60/162-59 (2464)		60/111-3 (1087/PK) (Repl. CAV 296)	
Panther 90	60/161-59 (2449) Couvercle / Cap Ø 133mm (↔ Série / Serie 5000)	60/162-59 (2464)	60/97-38 (309/F)	60/111-4 (1193/F) (Repl. CAV 796)	
	60/161-60 (2465) Couvercle / Cap Ø 155mm (Série / Serie 5001 ↔)	60/162-25 (2466)			
	ou / or 60/161-104 (TFA.581) Couvercle / Cap Ø 214mm	60/162-25 (2466)			
Panther 95	60/161-60 (2465) Couvercle / Cap Ø 155mm (↔ Série / Serie 2606)	60/162-25 (2466)			60/240-65 (SLT.4419/260) Ht.: 211mm Filet / Thread 1"
	60/161-104 (TFA.581) Couvercle / Cap Ø 214mm (Série / Serie 2607 ↔)	60/162-25 (2466)			
Ranger 45, 45 Frutteto	60/161-63 (2500)	60/162-1 (568)	60/97-2 (599AR/F)	60/111-3 (1087/PK) (Repl. CAV 296)	
Row Crop 80	60/161-62 (2498)		60/97-36 (294/F)		60/240-64 (SLT.4419/250) Ht.: 143mm Filet / Thread 1" ou / or 60/240-69 (SLT.4419/350) Ht.: 180mm Filet / Thread M40x2

Les références des pièces sont indicatives.
Nos pièces ne sont pas d'origine.

Part numbers are quoted for reference purposes only.
Our parts and accessories are not original.



"THE RELIABLE SERVICE"



Tracteurs Tractors	1		2	3	4
	Air		Huile Oil	Combustible Fuel	Hydraulique Hydraulic
	Ext. / Out.	Int. / Inn.			
Row Crop 85	60/161-62 (2498) ou / or 60/161-66 (7293) (Conique 2 pattes Conical type 2 fixings holes) (↔ 12/82) 60/161-112 (TM.254) (Conique, vis centrale Conical type, central nut) (1/83 ↔)	60/162-66 (7285) 60/162-112 (TM.255)	60/97-36 (294/F)	60/111-3 (1087/PK) (Repl. CAV 296)	60/240-69 (SLT.4419/350) Ht.: 180mm Filet / Thread M40x2
Sametto, Sametto 120				60/111-28 (1009)	
Sametto V, VDT			60/96-24 (101/F)		
Saturno 80 (2RM / WD), Saturno 80 (4RM / WD)	60/161-63 (2500) Ht.: 235mm (↔ Série / Serie 9356) 60/161-62 (2498) Ht.: 265mm (Série / Serie 9357 ↔)	60/162-62 (2499)	60/97-36 (294/F)	60/111-3 (1087/PK) (Repl. CAV 296)	
Saturno 80 Syncro	60/161-62 (2498)	60/162-62 (2499)			
Silver 80.DT (2RM / WD) Moteur 1000.4-A4 80HP Engine					60/240-66 (SLT.4419/280) Ht.: 232mm Filet / Thread M40x2
Silver 90.DT (2RM / WD) Moteur 1000.4AT2 90HP Engine			60/97-22 (169)		
Silver 100.4 DT Moteur 1000.4AT1 100HP Engine	60/161-104 (TFA.581)	60/162-25 (2466)	60/97-21 (121)	60/111-4 (1193/F) (Repl. CAV 796)	60/240-67 (SLT.4419/320) Ht.: 264mm Filet / Thread M40x2
Silver 100.6 Moteur 1000.6A1 100HP Engine					
Sirenetta (2RM / WD), (4RM / WD)	60/161-87 (2477) Ht.: 185mm ou / or 60/162-63 (2500) Ht.: 235mm		60/97-4 (305/F)	60/111-3 (1087/PK) (Repl. CAV 296)	

Les références des pièces sont indicatives.
Nos pièces ne sont pas d'origine.

Part numbers are quoted for reference purposes only.
Our parts and accessories are not original.



"THE RELIABLE SERVICE"



Tracteurs Tractors	1		2	3	4
	Air		Huile Oil	Combustible Fuel	Hydraulique Hydraulic
Ext. / Out.	Int. / Inn.				
Solar 50	60/161-112 (TM.254)	60/162-112 (TM.255)	60/97-2 (599AR/F)	60/111-3 (1087/PK) (Repl. CAV 296)	60/240-66 (SLT.4419/280) Ht.: 232mm Filet / Thread M40x2
Solar 55, 55C, 55C Compact, 60			60/97-36 (294/F)		60/240-69 (SLT.4419/350) Ht.: 180mm Filet / Thread M40x2
Solar 60C Ergomatic					
Solaris 35 Moteur Mitsubishi K4F-D Engine	60/161-63 (2500)	60/162-1 (568)	60/240-66 (SLT.4419/280)		
Taurus C			60/97-2 (599AR/F)	60/111-3 (1087/PK) (Repl. CAV 296)	
Taurus 60 Export	60/161-59 (2449) (↔ Série / Serie 2675)	60/162-59 (2464)	60/97-36 (294/F)		60/240-64 (SLT.4419/250) Ht.: 143mm Filet / Thread 1"
	60/161-66 (7293) (Conique, 2 pattes Conical type 2 fixings holes) (Série / Serie 2676 ↔)	60/162-66 (7285)			
	ou / or 60/161-112 (TM.254) (Conique, vis centrale Conical type, central nut)	60/162-112 (TM.255)			
Tiger 100 (2RM / WD), Tiger 100 (4RM / WD)	60/161-60 (2465) Couvercle / Cap Ø 155mm (↔ 8/81)	60/162-25 (2466)	60/97-38 (309/F)	60/111-3 (1087/PK) (Repl. CAV 296)	
	60/161-104 (TFA.581) Couvercle / Cap Ø 214mm (9/81 ↔)	60/162-25 (2466)		60/111-4 (1193/F) (Repl. CAV 796)	
Tiger Six 105				60/111-4 (1193/F) (Repl. CAV 796)	60/240-65 (SLT.4419/260) Ht.: 211mm Filet / Thread 1"
Titan 145	60/161-64 (2553)	60/162-64 (TFA.734)	60/97-21 (121)	60/111-4 (1193/F) (Repl. CAV 796)	60/240-67 (SLT.4419/320) Ht.: 264mm Filet / Thread M40x2
Titan 160 Turbo Moteur 1000.6AT1 159HP Engine					
Titan 190 Turbo Moteur 1000.6WTIR 189HP Engine					

Les références des pièces sont indicatives.
Nos pièces ne sont pas d'origine.

Part numbers are quoted for reference purposes only.
Our parts and accessories are not original.



"THE RELIABLE SERVICE"



Tracteurs Tractors	1		2	3	4
	Air		Huile Oil	Combustible Fuel	Hydraulique Hydraulic
	Ext. / Out.	Int. / Inn.			
Trident 130 Export	60/161-60 (2465) Couvercle / Cap Ø 155mm (↔ 8/81)	60/162-25 (2466)	60/97-38 (309/F)	60/111-4 (1193/F) (Repl. CAV 796)	60/240-67 (SLT.4419/320) Ht.: 264mm Filet / Thread M40x2
	60/161-104 (TFA.581) Couvercle / Cap Ø 214mm (9/81 ↔)	60/162-25 (2466)			
Toro, Toro V, AT, TS			60/96-3 (102T)	60/111-64 (F.1007) + 60/111-32 (1007)	
Vigneron 35, 45, 50	60/161-63 (2500) Ht.: 235mm		60/97-4 (305/F)	60/111-3 (1087/PK) (Repl. CAV 296)	
Vigneron 60, 62, 70	60/161-112 (TM.254)	60/162-112 (TM.255)	60/97-36 (294/F)		

Filtre de direction assistée
Power steering filter
60/574-15
 (S.136/6376)

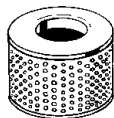
 Ø 86mm
 Ht.: 38mm

Leopard, Centurion, ...

 Les références des pièces sont indicatives.
 Nos pièces ne sont pas d'origine.

 Part numbers are quoted for reference purposes only.
 Our parts and accessories are not original.

FILTRATION - LAMBORGHINI
FILTERS - LAMBORGHINI

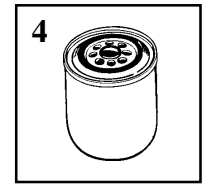
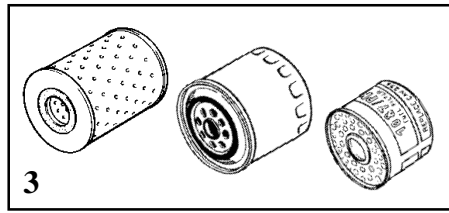
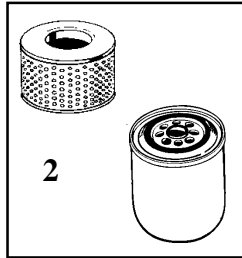
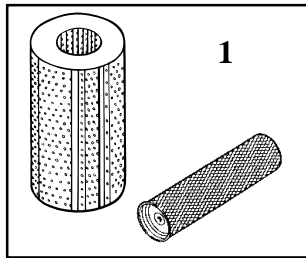

Tracteurs Tractors	1 Air		2 Huile Oil	3 Combustible Fuel	4 Hydraulique Hydraulic
	Ext. / Out.	Int. / Inn.			
1R, 1C				60/111-32 (1007)	
2R, 4R, 5C, 4C				60/111-64 (F.1007)	
7R, 7RDT, R 355				+ 60/111-32 (1007)	60/96-3 (102T)
105 Formula Power Speed				60/111-3 (1087/PK) (Repl. CAV 296)	
115, 135 Formula Moteur 100.WT6 Engine	60/161-104 (TFA.581)	60/162-25 (2466)	60/97-38 (309/F)	60/111-16 (1194/F)	60/240-69 (SLT.4419/350) Ht.: 180mm Filet / Thread M40x2
165, 190 Racing Moteur 100.WT6 Turbo Engine				+ 60/111-25 (5006/F)	
165 Racing			60/97-22 (169)	60/111-4 (1193/F) (Repl. CAV 796)	
R 226, C 226				60/111-32 (1007)	60/96-2 (103)
R 230, C 230, C 230S					
R 235, R 235DT	60/161-63 (2500)	60/162-1 (568)	60/97-4 (305/F)	60/111-3 (1087/PK) (Repl. CAV 296)	
R 240			60/97-36 (294/F)	60/111-39 (1158)	
R 340, C 340, C 350				60/111-64 (F.1007) + 60/111-32 (1007)	
R 345	60/161-112 (TM.254) (Conique, vis centrale Conical type, central nut)	60/162- 112 (TM.255)	60/97-36 (294/F)	60/111-3 (1087/PK) (Repl. CAV 296)	

Les références des pièces sont indicatives.
Nos pièces ne sont pas d'origine.

Part numbers are quoted for reference purposes only.
Our parts and accessories are not original.



"THE RELIABLE SERVICE"



Tracteurs Tractors	1		2	3	4
	Air		Huile Oil	Combustible Fuel	Hydraulique Hydraulic
	Ext. / Out.	Int. / Inn.			
R 350			60/97-38 (309/F)	60/111-39 (1158)	
C 352, C 352L, C 352S, C 352SL	60/161-8 (2543)	60/162-8 (2544)	60/97-4 (305/F)	60/111-3 (1087/PK) (Repl. CAV 296)	
C 353L, C 353LL, CL 653, C 653L			60/97-2 (599AR/F)		
R 360, R 365, 452, R 470, R 475, 480, 485				60/111-64 (F.1007) + 60/111-32 (1007)	
C 483			60/97-4 (305/F)	60/111-3 (1087/PK) (Repl. CAV 296)	60/240-68 (SLT.4419/270) Ht.: 186mm Filet / Thread 1 1/8"
R 500, R 550DT	60/161-112 (TM.254) (Conique, vis centrale Conical type, central nut)	60/162-112 (TM.255)	60/97-2 (599AR/F)		
C 503, C 603 Moteur Same 983P Engine	60/161-8 (2543)	60/162-8 (2544)			
C 503S, C 553S				60/240-46 (652)	
R 503S, R 503DTS, R 603, R 603DT			60/97-38 (309/F)	60/111-39 (1158)	60/240-11 (529) (Cartouche Cartridge)
C 553P, C 653P Moteur Same 1053P Engine			60/97-4 (305/F)	60/111-3 (1087/PK) (Repl. CAV 296)	
C 554, C 554 Compact Ergomatic 554-50, 564-60 Moteur 1003.3A Engine	60/161-112 (TM.254) (Conique, vis centrale Conical type, central nut)	60/162-112 (TM.255)	60/97-36 (294/F)		
574-74 Moteur 1003.3A Engine, R 574-60N, R 674-70, R 674-70N, C 674-70 Ergomatic, R 674-70 Grand Prix					60/240-69 (SLT.4419/350) Ht.: 180mm Filet / Thread M40x2
C 583			60/97-4 (305/F)		60/240-68 (SLT.4419/270) Ht.: 186mm Filet / Thread 1 1/8"
R 583			60/97-38 (309/F)		
R 600, R 600DT	60/161-112 (TM.254) (Conique, vis centrale Conical type, central nut)	60/162-112 (TM.255)	60/97-36 (294/F)		60/240-66 (SLT.4419/280) Ht.: 232mm Filet / Thread M40x2
C 653			60/97-4 (305/F)		

Les références des pièces sont indicatives.
Nos pièces ne sont pas d'origine.

Part numbers are quoted for reference purposes only.
Our parts and accessories are not original.



"THE RELIABLE SERVICE"



Tracteurs Tractors	1		2	3	4
	Air		Huile Oil	Combustible Fuel	Hydraulique Hydraulic
	Ext. / Out.	Int. / Inn.			
R 653, R654, R654DT					60/240-11 (529) (Cartouche Cartridge)
R 660, R 660DT, C664 Ergomatic	60/161-112 (TM.254) (Conique, vis centrale Conical type, central nut)	60/162- 112 (TM.255)	60/97-36 (294/F)	60/111-3 (1087/PK) (Repl. CAV 296)	
R 660 Frutteto, R 660 Vigneto, R 775 Frutteto					
C 683			60/97-4 (305/F)		60/240-68 (SLT.4419/270) Ht.: 186mm Filet / Thread 1 1/8"
R 683			60/97-36 (294/F)		60/240-66 (SLT.4419/280) Ht.: 232mm Filet / Thread M40x2
C 684, R 684					
R 700, R 700DT	60/161-104 (TFA.581)	60/162-25 (2466)			
R 704, R 704DT, R 804, R 804DT Export				60/111-56 (1157/F)	
R 754, R 754DT			60/97-36 (294/F)	60/111-3 (1087/PK) (Repl. CAV 296)	60/96-28 (394) (Cartouche Cartridge)
R 754 Ergomatic					60/240-66 (SLT.4419/280) Ht.: 232mm Filet / Thread M40x2
C 774-80 Ergomatic, R 774-80, R 774-80 Grand Prix	60/161- 104 (TFA.581)	60/162-25 (2466)			60/240-68 (SLT.4419/270) Ht.: 186mm Filet / Thread 1 1/8"
R 775 Frutteto, R 775 Vigneto, 775F Plus Moteur 1003.3A Engine					60/240-69 (SLT.4419/350) Ht.: 180mm Filet / Thread M40x2
R 784, C 784					
R 854, R 854DT					60/96-28 (394) (Cartouche Cartridge) Ht.: 209mm ou / or 60/240-11 (529) (Cartouche Cartridge) Ht.: 177mm

Les références des pièces sont indicatives.
Nos pièces ne sont pas d'origine.

Part numbers are quoted for reference purposes only.
Our parts and accessories are not original.



"THE RELIABLE SERVICE"



Tracteurs Tractors	1		2	3	4
	Air		Huile Oil	Combustible Fuel	Hydraulique Hydraulic
	Ext. / Out.	Int. / Inn.			
R 874-90 Turbo, R 874-90 Turbo Grand Prix	60/161- 104 (TFA.581)	60/162-25 (2466)	60/97-22 (169)	60/111-3 (1087/PK) (Repl. CAV 296)	60/240-69 (SLT.4419/350) Ht.: 180mm Filet / Thread M40x2 (↔ 3/87) 60/240-68 (SLT.4419/270) Ht.: 186mm Filet / Thread 1 1/8" (4/87 ↔)
R 904, R 904DT Export	60/161-59 (2449)	60/162-59 (2464)		60/111-56 (1157/F)	
R 955			60/97-38 (309/F)	60/111-4 (1193/F) (Repl. CAV 796)	60/96-28 (394) (Cartouche Cartridge) (↔ 82) 60/240-68 (SLT.4419/270) Ht.: 186mm Filet / Thread 1 1/8" (83 ↔)
R 956, R 956DT, R956-100	60/161- 104 (TFA.581)	60/162-25 (2466)	60/97-36 (294/F)		60/240-66 (SLT.4419/280) Ht.: 232mm Filet / Thread M40x2
990F Plus Moteur 1000.4WT Engine					60/111-3 (1087/PK) (Repl. CAV 296)
R 1056, R 1056DT, R 1256			60/97-38 (309/F)	60/111-4 (1193/F) (Repl. CAV 796)	60/96-28 (394) (Cartouche Cartridge) ou / or 60/240-68 (SLT.4419/270) Ht.: 186mm Filet / Thread 1 1/8"
R 1106, R 1106DT	60/161- 104 (TFA.581)	60/162-25 (2466)	60/97-36 (294/F)		60/240-66 (SLT.4419/280) Ht.: 232mm Filet / Thread M40x2
R 1156, R 1156DT			60/97-38 (309/F)	60/111-3 (1087/PK) (Repl. CAV 296)	60/240-68 (SLT.4419/270) Ht.: 186mm Filet / Thread 1 1/8"
R 1306DT Turbo	60/161- 104 (TFA.581)	60/162-25 (2466)	60/97-22 (169)	60/111-4 (1193/F) (Repl. CAV 796)	60/240-66 (SLT.4419/280) Ht.: 232mm Filet / Thread M40x2

Les références des pièces sont indicatives.
Nos pièces ne sont pas d'origine.

Part numbers are quoted for reference purposes only.
Our parts and accessories are not original.



"THE RELIABLE SERVICE"



Tracteurs Tractors	1		2	3	4
	Air		Huile Oil	Combustible Fuel	Hydraulique Hydraulic
	Ext. / Out.	Int. / Inn.			
R 1356, R 1356DT	60/161-64 (2553)	60/162-64 (TFA.734)	60/97-38 (309/F)	60/111-4 (1193/F) (Repl. CAV 796)	60/240-68 (SLT.4419/270) Ht.: 186mm Filet / Thread 1 1/8" (↔ 12/81)
R 1506DT Turbo			60/97-21 (121)		60/111-57 (1167/F) (↔ 9/81)
R 1556DT				60/111-3 (1087/PK) (Repl. CAV 296) (10/81 ↔)	
R 1706DT Turbo				60/111-4 (1193/F) (Repl. CAV 796)	60/240-67 (SLT.4419/320) Ht.: 264mm Filet / Thread M40x2 (10/81 ↔)

Les références des pièces sont indicatives.
Nos pièces ne sont pas d'origine.

Part numbers are quoted for reference purposes only.
Our parts and accessories are not original.



"THE RELIABLE SERVICE"



FILTRATION - HÜRLIMANN
FILTERS - HÜRLIMANN

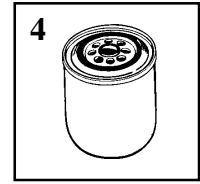
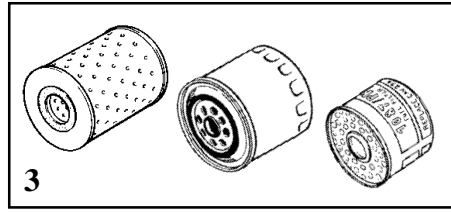
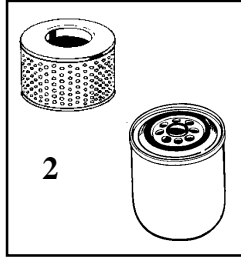
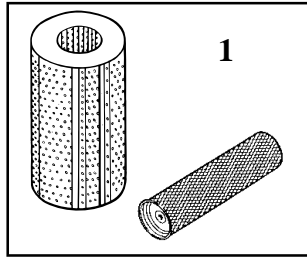

Tracteurs Tractors	1		2	3	4		
	Air		Huile Oil	Combustible Fuel	Hydraulique Hydraulic		
	Ext. / Out.	Int. / Inn.					
D 60, D 70, D 80, D 100				60/111-33 (1008)			
D 95, D 100, D 110, D 115, D 115T, D 150, D 310T			60/97-27 (439)	60/111-56 (1157/F)			
D 120				60/111-33 (1008)			
D 180, D 210, D 310, D 500				60/111-56 (1157/F)			
H 35FDT			60/97-36 (294/F)	60/111-3 (1087/PK) (Repl. CAV 296)	60/240-69 (SLT.4419/350) Ht.: 180mm Filet / Thread M40x2		
H 345			60/97-2 (599AR/F)				
H 351	60/161-112 (TM.254)	60/162-112 (TM.255)	60/97-36 (294/F)				
H 355, H 360, H 460, H 465, H 470, H 480, H 485	60/161-66 (7293) (Conique, fixation 2 pattes Conical, Installed with 2 screws)	60/162-66 (7285)					
H 356, H 466, H 466-4	60/161-112 (TM.254)	60/162-112 (TM.255)					
H 358-4, H 358 Prestige							
H 360	60/161-66 (7293) (Conique, fixation 2 pattes Conical, Installed with 2 screws)	60/162-66 (7285)					
H 361, H 361 Frutteto	60/161-112 (TM.254)	60/162-112 (TM.255)					
							60/240-69 (SLT.4419/350) Ht.: 180mm Filet / Thread M40x2 (↔ 12/87)
							60/240-66 (SLT.4419/280) Ht.: 232mm Filet / Thread M40x2 (1/88 ↔)

Les références des pièces sont indicatives.
Nos pièces ne sont pas d'origine.

Part numbers are quoted for reference purposes only.
Our parts and accessories are not original.



Tracteurs Tractors	1		2	3	4			
	Air		Huile Oil	Combustible Fuel	Hydraulique Hydraulic			
	Ext. / Out.	Int. / Inn.						
H 362	60/161-112 (TM.254)	60/162-112 (TM.255)	60/97-36 (294/F)	60/111-3 (1087/PK) (Repl. CAV 296)	60/240-66 (SLT.4419/280) Ht.: 232mm Filet / Thread M40x2			
H 372, H 372DT	60/161-104 (TFA.581)	60/162-25 (2466)			60/97-22 (169)	60/240-69 (SLT.4419/350) Ht.: 180mm Filet / Thread M40x2		
H 372 Turbo moteur 1000.3AT engine								
H 460, H 465 moteur 1000.3A engine	60/161-66 (7293) (Conique, fixation 2 pattes Conical, Installed with 2 screws)	60/162-66 (7285)	60/97-36 (294/F)		60/240-69 (SLT.4419/350) Ht.: 180mm Filet / Thread M40x2			
H 466-4 moteur 1000.3A engine	60/161-112 (TM.254)	60/162-112 (TM.255)						
H 468, H 468 Club, H 478, H 478-4, H 478 Prestige	60/161-104 (TFA.581)	60/162-25 (2466)	60/97-22 (169)				60/240-69 (SLT.4419/350) Ht.: 180mm Filet / Thread M40x2	
H 476, H 476 Frutteto								
H 488T								
H 490	60/161-102 (9516K)	60/162-102 (9637)	60/97-38 (309/F)					60/96-28 (394)
H 496T	60/161-104 (TFA.581)	60/162-25 (2466)	60/97-22 (169)					60/111-4 (1193/F) (Repl. CAV 796)
H 4105 Elite			60/97-38 (309/F)	60/240-66 (SLT.4419/280) Ht.: 232mm Filet / Thread M40x2				
H 5105	60/161-102 (9516K) Ht.: 342mm (↔ 8/81)	60/162-102 (9637)	60/97-21 (121)	60/111-16 (1194/F) (↔ 8/81)				
H 5110 moteur 5 cyl. engine						60/161-104 (TFA.581) Ht.: 395mm (9/81 ↔)		
H 5116 TURBO	60/161-104 (TFA.581)	60/162-25 (2466)	60/97-38 (309/F)	60/111-4 (1193/F) (Repl. CAV 796)				
H 6115T			60/97-21 (121)		60/240-66 (SLT.4419/280) Ht.: 232mm Filet / Thread M40x2			
H 6125, H 6155	60/161-72 (9631)		60/97-38 (309/F)					

Les références des pièces sont indicatives.
Nos pièces ne sont pas d'origine.

Part numbers are quoted for reference purposes only.
Our parts and accessories are not original.



"THE RELIABLE SERVICE"



Tracteurs Tractors	1		2	3	4
	Air		Huile Oil	Combustible Fuel	Hydraulique Hydraulic
	Ext. / Out.	Int. / Inn.			
H 6130	60/161-102 (9516K) Ht.: 342mm (Avec ailettes <i>With fins</i>) ou / or 60/161-83 (944) Ht.: 345mm (Sans ailettes <i>Less fin</i>)	60/162-102 (9637) 60/162-83 (9617)	60/97-38 (309/F)	60/111-4 (1193/F) (Repl. CAV 796)	60/240-66 (SLT.4419/280) Ht.: 232mm Filet / Thread M40x2
H 6135 Elite moteur 1000.6WT Turbo engine			60/97-22 (169)		
H 6136	60/161-104 (TFA.581)	60/162-25 (2466)	60/97-38 (309/F)		
H 6136 Turbo			60/97-21 (121)		
H 6160 Turbo	60/162-83 (944)	60/162-83 (9617)			
H 6170T	60/161-64 (2553)	60/162-64 (TFA.734)			
T 5200, T 6200, T 7700			60/97-2 (599AR/F)	60/111-56 (1157/F)	

Références interchangeables Same - Lamborghini - Hürlimann
Cross reference Same - Lamborghini - Hürlimann

Réf. OEM OEM Ref.	Réf. Cde Order Nr.	Réf. OEM OEM Ref.	Réf. Cde Order Nr.	Réf. OEM OEM Ref.	Réf. Cde Order Nr.	Réf. OEM OEM Ref.	Réf. Cde Order Nr.
001.0780.0	60/111-65	2.4249.050.1	60/161-62	2.4249.131.0	60/161-104	2.4419.130.1	60/97-2
001.0780.7	60/111-33	2.4249.050.4	60/162-8	2.4249.170.6	60/161-8	2.4419.140.1	60/97-4
002.7793.0	60/96-3	2.4249.060.1	60/161-59	2.4249.190.1	60/161-63	2.4419.150.1	60/97-2
002.7794.0	60/96-24	2.4249.060.8	60/161-59	2.4249.250.1	60/161-66	2.4419.170.1	60/97-40
003.1407.0	60/111-28	2.4249.070.2	60/162-59	2.4249.250.2	60/162-66	2.4419.190.1	60/240-46
003.1408.0	60/111-28	2.4249.070.4	60/162-59	2.4249.280.1	60/162-64	2.4419.210.1/10	60/240-68
003.1412.0	60/111-64	2.4249.080.1	60/161-8	2.4249.280.3	60/161-64	2.4419.250.2	60/240-64
003.1413.0	60/111-32	2.4249.080.2	60/162-8	2.4249.290.1	60/161-102	2.4419.260.2	60/240-65
041.1553.0	60/97-38	2.4249.090.1	60/161-54	2.4249.310.0/10	60/161-104	2.4419.270.1	60/240-68
041.1556.0	60/97-38	2.4249.110.1	60/161-62	2.4249.310.4	60/161-104	2.4419.280.1	60/240-66
044.1551.0	60/97-36	2.4249.110.2	60/161-62	2.4249.340.1	60/161-112	2.4419.320.0	60/240-67
044.1567.0	60/97-36	2.4249.120.1	60/162-62	2.4249.340.2	60/162-112	2.4419.340.0	60/97-22
052.1565.0	60/97-21	2.4249.120.5	60/162-62	2.4319.060.1	60/111-3	2.4419.350.0	60/240-69
136.6376-2/10	60/574-15	2.4249.130.0	60/161-104	2.4319.130.1	60/111-4	2.4419.410.0	60/240-68
2.4249.010.1	60/161-87	2.4249.130.1	60/161-60	2.4319.500.1	60/111-56	2.4529.030.9	60/574-15
2.4249.010.6	60/161-87	2.4249.130.2	60/162-25	2.4319.530.3	60/111-64	4 004 608	60/96-3
2.4249.020.1	60/161-54	2.4249.130.7	60/162-25	2.4319.530.4	60/111-32	7016.255.0	60/240-11
2.4249.040.2	60/162-1	2.4249.130.8	60/161-60	2.4419.041.1	60/96-19	9032.259.0	60/96-28
2.4249.040.3	60/162-1	2.4249.130.9	60/162-25	2.4419.100.2	60/97-25		

 Les références des pièces sont indicatives.
 Nos pièces ne sont pas d'origine.

 Part numbers are quoted for reference purposes only.
 Our parts and accessories are not original.

**ECHAPPEMENTS
SILENCERS**

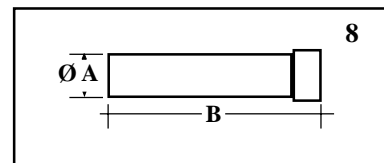
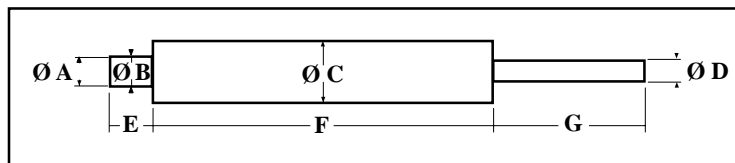
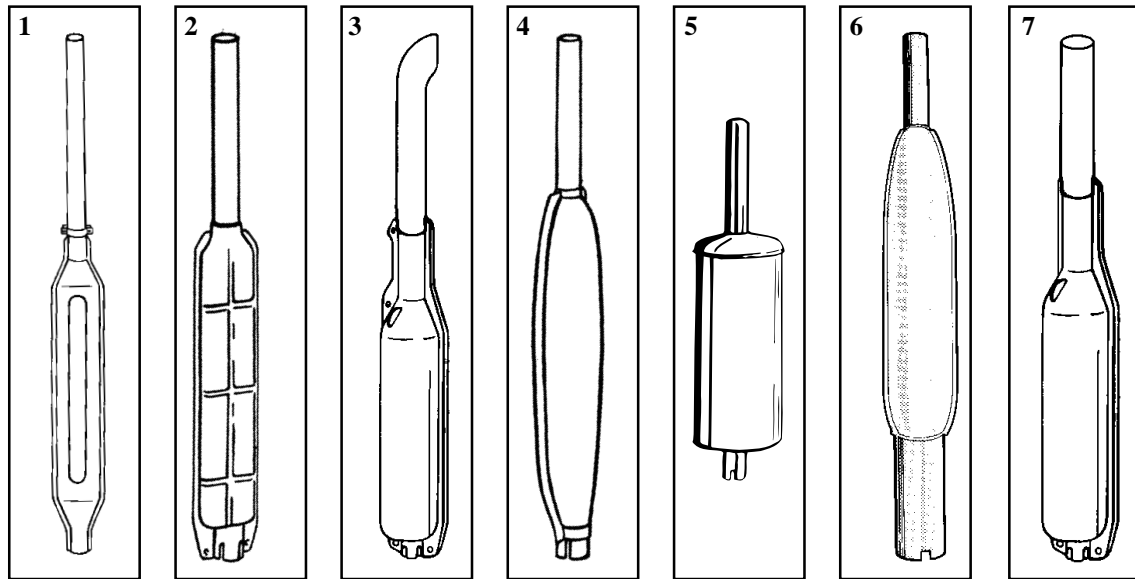

Tracteurs Tractors	Référence Reference	Fig. Fig.	Forme Shape	Tuyau Pipe	ØA	ØB	Ø C1-C2	ØD	E	F	G
H.468 Prestige, H.466, H.476, H.478, H.470 Lamb. 674, 774, 874 Aster 60, Explorer 90 Turbo, Explorer 60, 65, 70, 75, 80	S.255/6303 (25556303/30)	4	Rond Round		66	72	120	42	60	700	300
Laser 100, 110, 130 Tiger Six 105, Trident 130, Buffalo 130	S.170/5630 (17056303)	2	Rect. Rect.		65	73	178/92	48	40	930	280
Delfino 35, Minitauro 60, Corsaro 70 Synchro	S.150/5610 (1505610210)	3	Carré Square		52	60	90/100		50	600	150
Leopard 90 Turbo, Laser 90	S.250/5630 (25056303)	7	Rond Round		65	70	150	43	65	650	485
Selon applications Some applications	SLT.5610/65	5	Oval Oval		65	70	90/173	61	70	560	440
	SLT.5610/75				75	78	125/210	70	120	720	290
	SLT.5610/54	1	Carré Square		54	58	93/96	45	110	620	460
	SLT.5610/80	6	Rond Round		80	84	112	50	210	690	435
	SLT.5610/50	1			50	54	98	45	100	660	410
Antares 100 Explorer II -60, 70, 80, 90		8		29/166-10 (00839200/20)	80	1115					
Antares 110, 130 Titan 145, 160, 190				29/166-11 (00765140/20)	60	1080					



Les références des pièces sont indicatives.
Nos pièces ne sont pas d'origine.

Part numbers are quoted for reference purposes only.
Our parts and accessories are not original.



ECLAIRAGE - PHARES AVANTS
LIGHTING - FRONT LIGHT

SAME

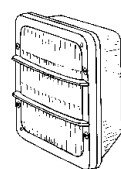
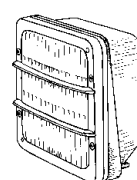
29/8029-900	2.8029.900 2.8029.910.0/10	Optique de phare <i>Front light lens</i>		Explorer série II / <i>Serie</i> Antares 100
29/7.5269	007.5269.0/10	Optique de phare <i>Front light lens</i>		Antares 110, 130 Titan
29/8029-670	2.8029.670.0 2.8029.680.0	Phare avant / <i>Front light</i> Fixation par clips / <i>Fitting with clips</i> Droit, modèle asymétrique / <i>Straight, asymmetrical model</i>		Laser, Explorer, Galaxy
		<u>Grille / Grille</u> : S.8029/342 (2.8029.340.2)		
		<u>Glace / Glass</u> : S.8029/341 (2.8029.340.1)		
		<u>Joint / Gasket</u> : S.8029/343 (2.8029.340.3)		
S.8029/170	2.8029.170.0/11 2.8029.180.0	Phare avant / <i>Front light</i> Fixation par clips / <i>Fitting with clips</i> Inclinaison 8° / <i>8° inclination</i>		
S.8029/160	2.8029.150.0/11 2.8029.160.0	Phare avant / <i>Front light</i> Fixation par clips / <i>Fitting with clips</i> Inclinaison 9° / <i>9° inclination</i>		
		<u>Grille / Grille</u> : S.8029/10N (2.8029.170.1/10)		
		<u>Glace / Glass</u> : S.8029/93 (2.8029.090.3)		
		<u>Joint / Gasket</u> : S.8029/94 (2.8029.090.4)		
S.8029/340	2.8029.390.0/01 2.8029.400.0/01	Phare avant / <i>Front light</i> Fixation par clips / <i>Fitting with clips</i> Inclinaison 8° / <i>8° inclination</i> Modèle asymétrique / <i>Asymmetrical model</i>		Tous modèles <i>All models</i> 1973-1983
		<u>Grille / Grille</u> : S.8029/342 (2.8029.340.2)		
		<u>Glace / Glass</u> : S.8029/341 (2.8029.340.1)		
		<u>Joint / Gasket</u> : S.8029/343 (2.8029.340.3)		



Les références des pièces sont indicatives.
Nos pièces ne sont pas d'origine.

Part numbers are quoted for reference purposes only.
Our parts and accessories are not original.



ECLAIRAGE - PHARES AVANTS
LIGHTING - FRONT LIGHT

LAMBORGHINI - HÜRLIMANN

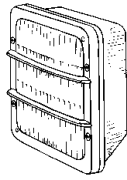
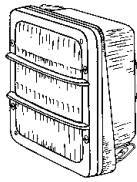
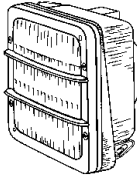
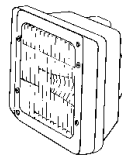
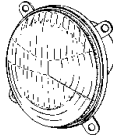
29/8029-900	2.8029.900	Optique de phare <i>Front light lens</i>		Séries 674, 774, 874 <i>Series</i>
29/8029-700	2.8029.700.0/10	Optique de phare <i>Front light lens</i>		Séries 956, 1256, 1356 <i>Series</i>
S.8029/630	2.8029.630.0	Phare avant / <i>Front light</i> Fixation par vis / <i>Screw connection</i> Droit / <i>Straight</i> <u>Grille / Grille</u> : S.8029/10N (2.8029.170.1/10) <u>Glace / Glass</u> : S.8029/93 (2.8029.090.3) <u>Joint / Gasket</u> : S.8029/94 (2.8029.090.4)		Suivant applications <i>Some applications</i>
SLT.8029/620	2.8029.260.0	Phare avant / <i>Front light</i> Fixation par clips / <i>Fitting with clips</i> Inclinaison 8° / <i>8° inclination</i> <u>Grille / Grille</u> : S.8029/10N (2.8029.170.1/10) <u>Glace / Glass</u> : S.8029/93 (2.8029.090.3) <u>Joint / Gasket</u> : S.8029/94 (2.8029.090.4)		Suivant applications <i>Some applications</i>
SLT.8029/660	2.8029.660.0	Phare avant / <i>Front light</i> Fixation par clips / <i>Fitting with clips</i> Inclinaison 8° / <i>8° inclination</i> Modèle asymétrique / <i>Asymmetrical model</i> <u>Grille / Grille</u> : S.8029/342 (2.8029.340.2) <u>Glace / Glass</u> : S.8029/341 (2.8029.340.1) <u>Joint / Gasket</u> : S.8029/343 (2.8029.340.3)		Suivant applications <i>Some applications</i>
27/1700HU	2.8029.410.0	Phare complet / <i>Complete front light</i> <u>Glace / Glass</u> : 27/1701HU		H.360, H.370
SLT.8029/310	2.8029.310.0/10	Optique de phare Ø 144mm <i>Front light lens Ø 144mm</i>		573, 673, R.654, R.674, R.684
SLT.188/250		Cercle de phare <i>Light circle</i>		
SLT.30/3323		Coiffe <i>Cowl</i>		



Les références des pièces sont indicatives.
Nos pièces ne sont pas d'origine.

Part numbers are quoted for reference purposes only.
Our parts and accessories are not original.

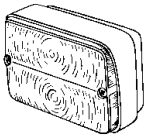
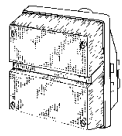
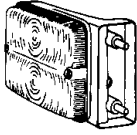

ECLAIRAGE - FEUX DE POSITION & CLIGNOTANTS
LIGHTING - SIDE LIGHTS & INDICATORS

SAME

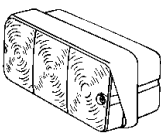
S.8019/20	2.8019.200.0/02	<u>Cabochon / Glass</u> : S.8019/201 (2.8019.200.1)		Suivant applications <i>Some applications</i>
S.8019/400	2.8019.480.0/02	<u>Cabochon / Glass</u> : S.8019/481		Taurus, Centurion
S.8019/960 (G/LH)	2.8019.960.0/02 402067AA	<u>Cabochon / Glass</u> : S.8019/201		Laser 110 Titan 145-160-190 Antares 100 Aster 60-70 Explorer II 60-70-80-90
S.8019/970 (D/RH)	2.8019.970.0/02			
S.8019/720	2.8019.720.0/10			Suivant applications <i>Some applications</i>

LAMBORGHINI - HÜRLIMANN

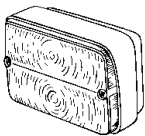
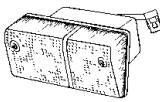
S.8019/20	2.8019.200.0/02	<u>Cabochon / Glass</u> : S.8019/201 (2.8019.200.1)		Suivant applications <i>Some applications</i>
S.8019/159 (D/RH)	400481AA	169 x 62 mm		Suivant applications <i>Some applications</i>
S.8019/158 (G/LH)	400480AA	<u>Cabochons / Glass</u> : S.8019/161 (D/RH) (2.8019.460.1) S.8019/160 (G/LH) (2.8019.470.1)		

Les références des pièces sont indicatives.
Nos pièces ne sont pas d'origine.

Part numbers are quoted for reference purposes only.
Our parts and accessories are not original.



ECLAIRAGE - FEUX ARRIÈRES
LIGHTING - REAR LIGHTS

SAME

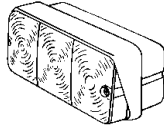
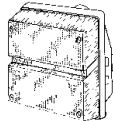
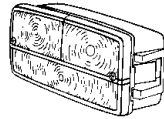
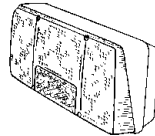
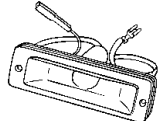
S.8019/19		Eclaire-plaque amovible <i>Removable number plate light</i> <u>Cabochon / Glass</u> : S.8019/181 (2.8019.860)		Same Delfino, Centaurio, Drago, Minitauro, Tiger
S.8019/430 (D/RH)	2.8019.490.0/02	Avec éclaire-plaque / <i>With number plate light</i> <u>Cabochons / Glass</u> : S.8019/490 (D/RH) (2.8019.490.1)		Centurion 75
S.8019/420 (G/LH)	2.8019.740.0/02	S.8019/740 (G/LH) (2.8019.740.1)		
SLT.8059/090 (D/RH)	2.8059.090.0/02 2.8059.160.0	177 x 81 mm <u>Cabochons / Glass</u> : SLT.8059/091 (D/RH) (2.8059.090.1)		Explorer
SLT.8059/080 (G/LH)	2.8059.150.0, 2.8059.080.0	SLT.8059/081 (G/LH) (2.8059.080.1)		
29/8019-980 (D/RH)	2.8019.980.0/20	280 x 120mm <u>Cabochons / Glass</u> : 29/8019-981 (D/RH) (2.8019.980.1)		Laser
29/8019-990 (G/LH)	2.8019.990.0/20	29/8019-991 (G/LH) (2.8019.990.1)		
29/8059-010		Eclaire-plaque / <i>Number plate light</i>		Explorer Laser-Galaxy

LAMBORGHINI - HÜRLIMANN

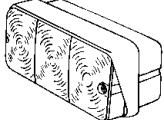
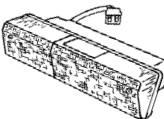
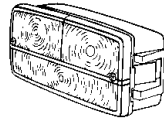
S.8019/19		Eclaire-plaque amovible <i>Removable number plate light</i> <u>Cabochon / Glass</u> : S.8019/181 (2.8019.860)		Séries 503, 653, 953, 956 Series
S.8019/2351 (D/RH)	2.8019.440.0 400483AA	300 x 60mm <u>Cabochons / Glass</u> : S.8019/2353 (D/RH) (2.8019.400.1)		Suivant applications <i>Some applications</i>
S.8019/2350 (G/LH)	2.8019.450.0 400482AA	S.8019/2352 (G/LH) (2.8019.450.1)		
SLT.8059/090 (D/RH)	2.8059.090.0/02 2.8059.160.0	177 x 81 mm <u>Cabochons / Glass</u> : SLT.8059/091 (D/RH) (2.8059.090.1)		H.356, H.466, H.478, H.488, R.674, 774, 874
SLT.8059/080 (G/LH)	2.8059.150.0, 2.8059.080.0	SLT.8059/081 (G/LH) (2.8059.080.1)		

Les références des pièces sont indicatives.
Nos pièces ne sont pas d'origine.

Part numbers are quoted for reference purposes only.
Our parts and accessories are not original.

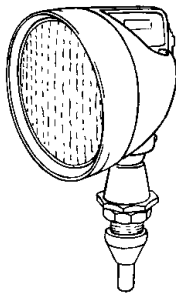

ECLAIRAGE - PHARES DE TRAVAIL
LIGHTING - PLOUGH LAMPS

S.8029/2T	280293000	Ø 105mm - Avec interrupteur Ø 105mm - With switch <u>Ampoule / Bulb</u> : 63/1955-96 (Ex. : 10/12247) 12V, 45W <u>Glace / Glass</u> : S.8029/590	
29/8029.460	280294600	Ø 125mm - Avec interrupteur Ø 125mm - With switch <u>Ampoule / Bulb</u> : 63/1955-96 (Ex. : 10/12247) 12V, 45W <u>Glace / Glass</u> : 29/8029/461	
SLT.8029/450	280294400	Ø 130mm - Avec interrupteur Ø 130mm - With switch <u>Ampoule / Bulb</u> : 63/1955-453 (Ex. : 10/12336) H3, 12V, 55W <u>Optique / Front light lens</u> : 29/8029/440	

63/1931-3
(ET.5171)

TWIN-POWER

Réflecteur à surface complexe
Boîtier plastique anti-choc
Très large amplitude
Halogène H3 - Sans poignée

*Work lamp with free-form reflector
Extremely wide-angled illumination
Halogen H3 - Less handle*

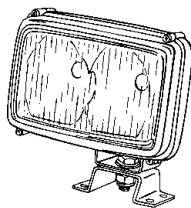

Ampoules / Bulbs : **63/1955-453** (12V./55W)(2x)
(Ex : 10/12336)

63/1931-5
(10/W.394)

Phare orientable 360°
Halogène H3 - 112 x 126mm
(Glace : 82 x 82mm)

*Adjustable lamp 360°
Halogen H3 - 112 x 126mm
(Glass : 82 x 82mm)*

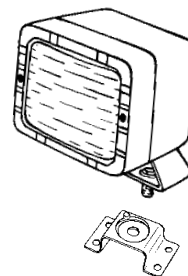

Ampoule / Bulb : **63/1955-453** (12V./55W)
(Ex : 10/12336)

63/1934-5 (ET.131) Support de 1931-5 / Bracket for 1931-5

63/1931-4
(ET.1253/F)

Halogène H3
Avec interrupteur

*Halogen H3
With switch*

Ampoule / Bulb : **63/1955-453** (12V./55W)
(Ex : 10/12336)

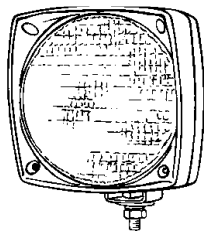

63/1931-6
(ET.1251/H)

182 x 100mm
Halogène H3
Halogen H3

Ampoule / Bulb : **63/1955-453** (12V./55W)
(Ex : 10/12336)

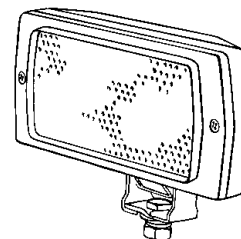

Les références des pièces sont indicatives.
Nos pièces ne sont pas d'origine.

Part numbers are quoted for reference purposes only.
Our parts and accessories are not original.



BOUTONS POUSSOIRS
BUTTONS

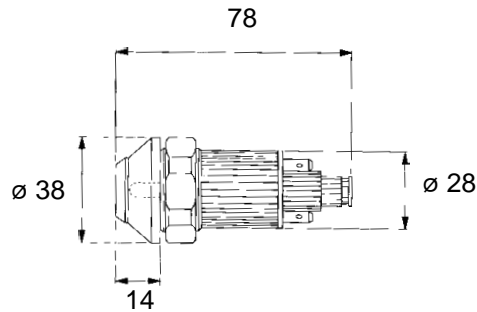

	Réf. Ref.	OEM	Description Description
	63/1884-4	S.L.H. 008.1277.0	Automatique Bouton poussoir "Push push" avec éclairage 12V <i>Automatic Push push switches with 12 V bulb</i>
	63/1884-5	S.L.H. 2.7659.111.0	Feu de travail arrière Bouton poussoir "Push push" avec éclairage 12V <i>Back side lights Push push switches with 12 V bulb</i>
	63/1884-6	S.L.H. 2.7659.109.0	Feu de travail avant Bouton poussoir "Push push" avec éclairage 12V <i>Front side light Push push switches with 12 V bulb</i>
	63/1884-7	S.L.H. 27659.118.0	Gyrophare Bouton poussoir "Push push" avec éclairage 12V <i>Rotating light Push push switches with 12 V bulb</i>
	63/1884-8	S.L.H. 008.1335.0	Blocage du différentiel Bouton poussoir "Push push" avec éclairage 12V <i>Differential lock Push push switches with 12 V bulb</i>
	63/1884-9	S.L.H. 007.5944.0/20	Blocage du différentiel Bouton poussoir "Push push" avec éclairage 12V <i>Differential lock Push push switches with 12 V bulb</i>
	63/1884-10	S.L.H. 007.5945.0/20	Enclenchement du pont avant Bouton poussoir "Push push" avec éclairage 12V <i>4 wheel drive Push push switches with 12 V bulb</i>
	63/1884-11	S.L.H. 2.7659.110.0	Feu de détresse Bouton poussoir "Push push" avec éclairage 12V <i>Hazard Push push switches with 12 V bulb</i>
	63/1884-12	S.L.H. 2.7659.113.0	Arrêt moteur Bouton poussoir "Push push" avec éclairage 12V <i>Engine stop Push push switches with 12 V bulb</i>
	63/1884-14	S.L.H. 2.7659.108.0/10	Commande de prise de force Bouton poussoir "Push push" avec éclairage 12V <i>P.T.O. command Push push switches with 12 V bulb</i>
	63/1884-20	S.L.H. 008.80490	Monter/descendre Bouton poussoir "Push" avec éclairage 12V <i>Lift & lower Push switches with 12 V bulb</i>

Les références des pièces sont indicatives.
Nos pièces ne sont pas d'origine.

Part numbers are quoted for reference purposes only.
Our parts and accessories are not original.



INSTRUMENTS DE BORD
INSTRUMENTS (MISCELLANEOUS)

COMPTE-HEURES
TACHOMETER

S.7049/610 Saturno, Corsaro, Mercury,
(270494300) Centurion, Centauro,
Taurus, Trident,
Tiger, Leopard, Jaguar

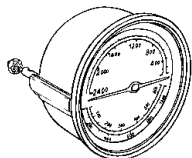

S.7049/270 Drago, Buffalo,
(270493200) Saturno, Corsaro

S.7049/660 Explorer 65, 70, 75, 80, 90
(27049660) Lamborghini : 674, 774, 874

RENOVI
GEAR DRIVE

S.7049/670 Explorer 65, 70, 75, 80, 90
Lamborghini :
674, 774, 874

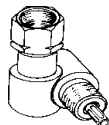

CABLES D'ARRET
STOP CABLE

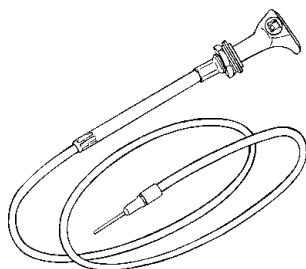

S.169/6730 Tiger Lg. : 795mm

29/169-6730 Buffalo, Tiger

TRANSMISSIONS FLEXIBLES
DRIVE CABLES

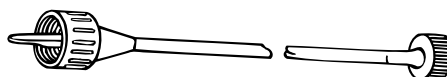

S.154/7464 Drago, Buffalo

S.158/7450 Corsaro, Saturno

S.167/7451 Same :
Buffalo, Leopard, Centurion, Hercule,
Taurus, Tiger, Jaguar
Lamborghini : 754
Hürlimann : 490

S.179/7435 Minitauro, Corsaro

29/235.7435 Explorer 55, 65, 70
Trident

29/255.7435 Explorer 75, 80,85, 90 (↔1 Série/Serie)
Lamborghini : 674, 774, 874

26/290.7435 Explorer 75, 80,85, 90 (↔2 Série/Serie)

29/264.7435 Laser 90, 100, 110, 130, 150
Galaxy

S.150/7462 Same :
Delfino 32
Lg. : 1150mm

SLT.150/7450 Lamborghini :
R854, 855, 1056, 1156
Lg. : 1000mm

CONNECTEUR
PLUG SOCKET

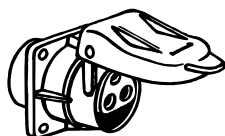

10/250110
Prise 2 pôles
2 point socket poles



10/250331
Prise 2 pôles
2 point socket poles

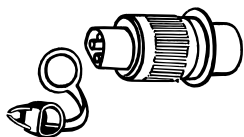

10/250112
Fiche 2 pôles
2 point socket

Les références des pièces sont indicatives.
Nos pièces ne sont pas d'origine.

Part numbers are quoted for reference purposes only.
Our parts and accessories are not original.



INSTRUMENTS DE BORD
INSTRUMENTS (MISCELLANEOUS)

INTERRUPTEURS RECTANGULAIRES
RECTANGULAR SWITCHES



- S.7659/23** Eclairage 3 positions - 7 plots
Lighting 3 positions - 7 plugs
- S.7659/30** Polyvalent - 2 plots
Polyvalent - 2 plugs
- S.7659/64** Phare de travail avant - 5 plots
Front plough lamps - 5 plugs
- 29/7659.065** Phare de travail arrière - 5 plots
Rear plough lamps - 5 plugs
- S.8819/090** Phare de travail 36x18,5
Plough lamps 36x18,5
- S.8819/110** Ventilation
Ventilation
- S.7659/070** Essuie & lave-glaces
Wiper
Antares 100, Aster 60, 70
Explorer II 60, 70, 80, 90

INTERRUPTEURS CLIGNOTANTS
INDICATORS SWITCHES

S.7649/4

Same
Lamborghini

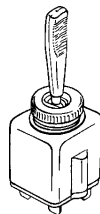

INTERRUPTEURS FEUX "STOP" & "PTO"
LIGHTS "STOP" & "PTO" SWITCH

S.7649/5
(276490500/10)

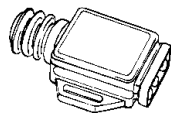

INTERRUPTEURS-SELECTEUR "PTO"
"PTO" SWITCH

- 29/7649-100** Sélecteur 540/1000T
Switch 540/1000T
Same
Antares, Titan
Lamborghini
Selon équipement
According fitment
Hürlimann

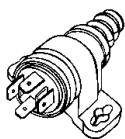

POUSSOIR AVERTISSEUR
HORN SWITCH

S.7409/17
(2.8819.010.0)



BOITE CLIGNOTANTE
FLASHING UNIT

29/8639-003 6 broches/6 pins
2+1+1(8)x21W

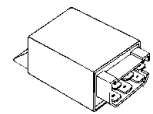

BOITE A FUSIBLES
FUSE HOLDERS

S.7719/002 6 fusibles/6 fuses
S.7719/004 8 fusibles/8 fuses
29/7719-12 12 fusibles/12 fuses

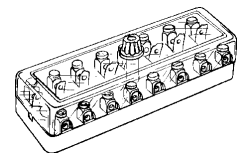

INDICATEURS LUMINEUX
ROCKERS INDICATORS SWITCHES

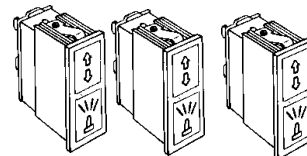

- S.8339/028** Rouge, préchauffage
Red, Starter switch
Vert, indicateur direction
Green, gauge steering
- S.8339/031** Rouge, PTO
Red, PTO
Vert, indicateur direction
Green, gauge steering
- S.8339/020** Vert/vert, remorques
Green/green, Trailers
- S.8339/600** Rouge/rouge, sans sigles
Red/red, less acronym.
- S.8339/019** Rouge, alternateur
Red, alternator
Rouge, pression d'huile
Red, Oil pressure switch
- S.8339/018** Bleu, feux avant
Blue, front lights
Rouge, niveau carburant
Red, Fuel gauge

Les références des pièces sont indicatives.
Nos pièces ne sont pas d'origine.

Part numbers are quoted for reference purposes only.
Our parts and accessories are not original.



INSTRUMENTS DIVERS
INSTRUMENTS (MISCELLANEOUS)

RELAIS
RELAYS

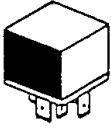
29/7659.016 (1.8050.000)		4 plots/plugs
29/7659.017 (1.8049.000)		3 plots/plugs
29/7659.018 (1.8038.000)		4 plots/plugs
29/7659.019 (1.8098.000)		5 plots/plugs
29/7659.099 (1.8073.000)		5 plots/plugs
S.7659/027 (1.8064.000)		5 plots/plugs
29/7659.028 (1.8059.000)		5 plots/plugs

CONTACTEURS D'ECLAIRAGE
LICHTING SWITCHES

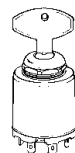

S.7410/1 0/1/2/3
Plots : 3 simples, 2 doubles
Plugs : 3 singles, 2 doubles

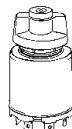

S.7409/3 0/1/2/3 + claxon/horn
(2.7409.030.0) Plots : 5 simples
Plugs : 5 singles



S.7409/060 0/1/2/3 + claxon/horn
(2.7409.060.0) Plots : 4 simples, 1 double
Plugs : 4 singles, 1 double

INTERRUPTEURS COMBINES
STEERING COLUMN SWITCHES

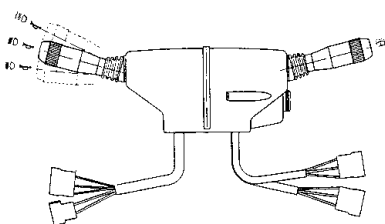

S.199/8551	R.653, 1256, 603
29/254.8450	R.653, 654, 1256
S.005/1849	Titan
29/7650.054 (276590540)	Explorer, Laser, Galaxy
S.008/1268 (00812684/20)	Same : Antares 110, 130 Titan 145, 160, 190 Lamborghini : Formula 115, 135 Racing 150, 165, 190 Hürlimann : Elite

REFROIDISSEUR D'HUILE
OIL COOLER

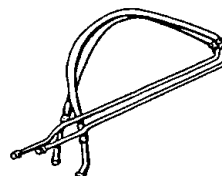

S.2115/422K	Centauro, Leone (Paire/paar)
S.37/1542	Drago Gauche/LH
S.37/1543	Drago Droit/RH

Les références des pièces sont indicatives.
Nos pièces ne sont pas d'origine.

Part numbers are quoted for reference purposes only.
Our parts and accessories are not original.

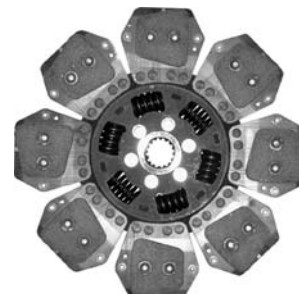

MECANISMES & DISQUES D'EMBRAYAGE
CLUTCH ASSEMBLIES & PLATES

SAME

Tracteurs Tractors	Embrayage Clutch		Disque Plate		Butée de débrayage Release Bearing
	Ø	N°	Ø	N°	
Antares 100 Row Crop 90 (1358 ⇔) Silver 100.6 (⇔ 3222)	310 DF Valéo	29/200- 500 Ø Ext. / Out. 368 mm (008.4293.3) (131 0229 30)	310	29/221-501 TC-LT 24Z 36x40 (008.4292.3) (331 0184 30)	29/231-500 55x91x26 (2.2999.193.0) (500 0076 20)
	310 DF B. & B.	29/200- 501 Ø Ext. / Out. 365 mm (294.2320.3) (131 0228 50)	310	29/221-502 TF 24Z 36x40 (445.2330.3) (331 0179 36)	
	330 DV Valéo	29/200-502 (008.4184.3) (133 0220 30)	330	29/221-503 TC-LT 24Z 36,5x41 (009.6533.3) (333 0116 30) 29/221-504 TF 24Z 36,5x41 (008.9937.3) (333 0117 30)	29/231- 501 MV Lg. 213 mm (2.2999.207.0) (500 0846 30)
Antares 100 110 II (⇔ 4243) 127 130 (⇔ 2026)	330 DV	29/200-502 (008.4184.3) (133 0220 30)	330	29/221-505 TC-LT 21Z 41x45 (009.9769.3) (333 0115 30)	
Antares 130 (2027 ⇔) 130 II 130 V	350 DV	29/200-503 (008.5595.3) (135 0241 10)	348	29/221-506 TC-LT 21Z 41x45 (0.008.5596.3) (335 0186 10)	
Argon 50	250/250 GU6	29/200-504 (122.564.4) (225 0055 10)	250 LG	29/221-507 UF 20Z 36x40 (122.565.3) (325 0198 10)	29/231-502 50x82 / 90x22 (2.2999.153.0) (500 0459 00) 29/231-503 65x100x18 (2.2021.017.0)
			225 LM	29/212-501 UF 10Z 22x25 (119.063.3) (323 0556 10)	

Les références des pièces sont indicatives.
Nos pièces ne sont pas d'origine

Part numbers are quoted for reference purposes only.
Our parts and accessories are not original.



MECANISMES & DISQUES D'EMBRAYAGE
CLUTCH ASSEMBLIES & PLATES

Tracteurs Tractors	Embrayage Clutch		Disque Plate		Butée de débrayage Release Bearing
	Ø	N°	Ø	N°	
Argon 60 70 Frutetto 85 II Rock 55, 60, 70	280/280 GU6	29/200-505 (122.574.4) (228 0133 10)	280 LG	29/221-508 UC-LT 20Z 36x40 (122.577.3) (328 0378 12)	29/231-502 50x82 / 90x22 (2.2999.153.0) (500 0459 00) 29/231-503 65x100x18 (2.2021.017.0)
280 LM			29/212-502 UC-LQ 14Z 22x25 (119.073.3) (328 0377 11)		
Argon Frutetto 60 II 75 II Rock 55, 60	280/280 GU6	29/200-506 (122.571.4) (228 0133 11)	280 LG	29/221-509 UC-LS 20Z 36x40 (122.572.3) (328 0378 11)	29/230-500 AU (2.2041.008.0)
280 LM			29/212-503 UC-LR 14Z 22x25 (119.067.3) (328 0377 10)		
Ariette	350/350 SAME		350 LG	29/221-528 UF 24Z 46x50 (263.2313.8)	
350 LG			29/221-510 UF-VZ 24Z 46x50		
350 LG			29/221-511 TF-VZ 24Z 46x50 (154.2213.3/10)		
350 LG			29/221-512 UC-LT 24Z 46x50		
350 LM			29/212-504 UF 17Z 28x32 (154.2222.3)		
Aster 60, 70 Suite page suivante <i>Continuation on following page</i>	280/280 GU6 Valéo	29/200-507 DV	280 LG	29/221-513 UC-LS 20Z 36x40 (328 0017 11)	29/231-502 50x82 / 90x22 (2.2999.153.0) (500 0459 00)
			280 LM	29/212-505 UF 14Z 22x25 (422.2222.3/20)	
	280/280 GU6 Luk	29/200-508 DV-AA-AN (228 0040 12)	280 LG	29/221-513 UC-LS 20Z 36x40 (328 0017 11)	29/231-504 70x110x20 29/230-500 AU (2.2041.008.0)
			280 LM	29/212-506 UF 14Z 22x25 (84751.3/10) (328 0318 30)	

 Les références des pièces sont indicatives.
 Nos pièces ne sont pas d'origine

 Part numbers are quoted for reference purposes only.
 Our parts and accessories are not original.

"THE RELIABLE SERVICE"

MECANISMES & DISQUES D'EMBRAYAGE
CLUTCH ASSEMBLIES & PLATES

Tracteurs Tractors	Embrayage Clutch		Disque Plate		Butée de débrayage Release Bearing
	Ø	N°	Ø	N°	
Aster 60, 70 Suite de la page précédente <i>Continuation from the previous page</i>	280/280 GU6 Luk	29/200-509 DV (228 0040 13)	280 LG	29/221-514 UF 20Z 36x40 (328 0017 16)	29/231-502 50x82 / 90x22 (2.2999.153.0) (500 0459 00)
280 LM			29/212-506 UF 14Z 22x25 (84751.3/10) (328 0318 30)	29/231-504 70x110x20	
Atlanta 55	250/280 SAME		250 LK	29/212-507 UF-VZ 20Z 36x40 (0.146.2222.3/10)	
			280 LN	29/221-515 VZ 10Z 23x29	
Aurora 45	230/250 SAME		230 LK	29/212-508 UF 14Z 36x40	
			250 LN	29/221-516 TF 10Z 21x25	
Buffalo 130	350 G3 SAME		350	29/221-517 UC-MH 24Z 46x50 (212.2359.3/10) (335 0162 30)	29/231-505 65x102x27
			350	29/221-510 UF-VZ 24Z 46x50	
			350	29/221-511 TF-VZ 24Z 46x50 (154.2213.3/10)	
			350	29/221-512 UC-LT 24Z 46x50	
Drago Drago 120	350/350 GU6 SAME		350 LG	29/221-528 UF 24Z 46x50 (263.2313.8)	
			350 LG	29/221-510 UF-VZ 24Z 46x50	
			350 LG	29/221-511 TF-VZ 24Z 46x50 (154.2213.3/10)	
			350 LG	29/221-512 UC-LT 24Z 46x50	
			350 LM	29/212-504 UF 17Z 28x32 (154.2222.3)	

Les références des pièces sont indicatives.
Nos pièces ne sont pas d'origine

Part numbers are quoted for reference purposes only.
Our parts and accessories are not original.



"THE RELIABLE SERVICE"



MECANISMES & DISQUES D'EMBRAYAGE
CLUTCH ASSEMBLIES & PLATES

Tracteurs Tractors	Embrayage Clutch		Disque Plate		Butée de débrayage Release Bearing
	Ø	N°	Ø	N°	
Centauro 60 Export 70 Corsaro 70	250/290 G3 SAME		250 LK 290 LN 290	29/212-509 UF-VZ 22Z 41x45 (135.2222.3) 29/221-518 UF-VZ 10Z 23x29 (157.2213.3) 29/221-519 UC-VZ 10Z 23x29	29/231-505 65x102x27
Centurion 75 (nr. 3371⇒) Leone 70, 80 Saturno 80 Mercury 85	265/320 GU6 SAME		265 LK 320 LN 320 LN 320 LN	29/212-510 UF-VZ 22Z 41x45 (136.2222.3/10) 29/221-520 UF-VZ 10Z 23x29 29/221-521 TF-VZ 10Z 23x29 29/221-522 TC-ML-VZ 10Z 23x29	
Condor 55 Corsaro 70 /S Falcon 50 Frutteto 60 Minitauro 60 Minitaurus 60 Taurus 60 Vigneron 60	250/280 GU6 Luk 250/280 GU6 Valéo	29/200- 510 DF Sans moyeu de commande de pompe hydraulique <i>Less hydraulic pump drive hub</i> (194.2210.4) (228 0067 11)	250 LK 250 LK 280 LN 250 LK 280 LN 280 LN	29/212-511 UF 20Z 36x40 (194.2222.3) (325 0114 16) 29/212-512 VZ 20Z 36x40 29/221-523 TF 14Z 22x25 (194.2213.3) (328 0127 16) 29/221-524 UF 20Z 36x40 (203.2222.3) 29/212-513 TF 14Z 22x25 (283.2213.3) (328 0270 36) 29/221-527 VZ 14Z 22x25	

 Les références des pièces sont indicatives.
 Nos pièces ne sont pas d'origine

 Part numbers are quoted for reference purposes only.
 Our parts and accessories are not original.

"THE RELIABLE SERVICE"

MECANISMES & DISQUES D'EMBRAYAGE
CLUTCH ASSEMBLIES & PLATES

Tracteurs Tractors	Embrayage Clutch		Disque Plate		Butée de débrayage Release Bearing
	Ø	N°	Ø	N°	
Dorado 60, 70 /DT	310 DF Valéo	29/200-500 Ø Ext. / Out. 368 mm (008.4293.3) (131 0229 30)	310	29/221-501 TC-LT 24Z 36x40 (008.4292.3) (331 0184 30)	
	310 DF B. & B.	29/200-501 Ø Ext. / Out. 365 mmm (294.2320.3) (131 0228 50)	310	29/221-502 TF 24Z 36x40 (445.2330.3) (331 0179 36)	
Explorer 55, 60, 65 Same 65	280 DF Valéo 6 goujons 6 studs	29/200-511 (255.2320.3/10) (128 0248 30)	280	29/221-526 TF 24Z 36x40 (270.2330.3/10)	29/231-500 55x91x26 (2.2999.193.0) (500 0076 20)
	280 DF B. & B. 8 goujons 8 studs	29/200-512 (255.230.3) (128 0243 50)			
Explorer 70, 75, 80, 90 70 II /DT (⇒ 22091) 90 /DT Spécial / Special 70, 70 II Spécial / Special Basso 70 II 80 II /LP Top 90 II Golden Compatto 75 85 /DT Row Crop 90 /DT (⇒ 1357)	310 DF Valéo	29/200-500 Ø Ext. / Out. 368 mm (008.4293.3) (131 0229 30)	310	29/221-501 TC-LT 24Z 36x40 (008.4292.3) (331 0184 30)	
	310 DF B. & B.	29/200-501 Ø Ext. / Out. 365 mmm (294.2320.3) (131 0228 50)	310	29/221-502 TF 24Z 36x40 (445.2330.3) (331 0179 36)	
Explorer 80 II /DT Spécial 80 (⇒ 15592) 80 /LP 80 II /LP 90 (⇒ 2974) 90 /LP (⇒ 1075) Top 90 II Silver 80, 90, 100.4	330 DV Valéo	29/200-502 (008.4184.3) (133 0220 30)	330	29/221-503 TC-LT 24Z 36,5x41 (009.6533.3) (333 0116 30)	29/231-501 MV lg. 213 mm (2.2999.207.0) (500 0846 30)
				29/221-504 TF 24Z 36,5x41 (008.9937.3) (333 0117 30)	
Falcon N°3241⇒	250/280 3GU SAME		280 LN	29/221-527 VZ 14Z 22x25	29/231-505 65x102x27
			250 LK	29/212-507 VZ 20Z 36x40 (146.2222.3/10)	

Les références des pièces sont indicatives.
Nos pièces ne sont pas d'origine



"THE RELIABLE SERVICE"



Part numbers are quoted for reference purposes only.
Our parts and accessories are not original.

MECANISMES & DISQUES D'EMBRAYAGE
CLUTCH ASSEMBLIES & PLATES

Tracteurs Tractors	Embrayage Clutch		Disque Plate		Butée de débrayage Release Bearing	
	Ø	N°	Ø	N°		
Frutetto 60 II, 75 II ⇒ Voir / See Argon						
Frutetto 85 II ⇒ Voir / See Argon 60						
Galaxy 170	350 DV Valéo	29/200-513 (269.2310.4) (135 0230 30)	350	29/221-517 UC-MH 24Z 46x50 (212.2359.3/10) (335 0162 30)		
	350 SAME		350			29/221-512 UC-LT 24Z 46x50
			350			29/221-528 UF 24Z 46x50 (263.2313.8)
			350			29/221-510 UF 24Z 46x50
			350			29/221-511 TF 24Z 46x50 (154.2213.3/10)
Golden Compatto 75, 85 /DT ⇒ Voir / See Explorer						
Hercules 160	350 DV Valéo	29/200-513 (269.2310.4) (135 0230 30)	350	29/221-517 UC-MH 24Z 46x50 (212.2359.3/10) (335 0162 30)		
	350 SAME		350			29/221-512 UC-LT 24Z 46x50
			350			29/221-510 UF 24Z 46x50
			350			29/221-511 TF 24Z 46x50 (154.2313.3/10)
				29/231-505 65x102x27		

Les références des pièces sont indicatives.
Nos pièces ne sont pas d'origine

Part numbers are quoted for reference purposes only.
Our parts and accessories are not original.



"THE RELIABLE SERVICE"



MECANISMES & DISQUES D'EMBRAYAGE
CLUTCH ASSEMBLIES & PLATES

Tracteurs Tractors	Embrayage Clutch		Disque Plate		Butée de débrayage Release Bearing
	Ø	N°	Ø	N°	
Jaguar 95 Léopard 85, 90 Panther 95	330 4 doigts + bague d'appui 4 levers + split ring B. & B.	29/200-514 Volant plat <i>Flat flywheel</i> (176.235.4) (133 0027 50)	330	29/221-529 TF 24Z 46x50 (176.2352.3)	29/231-505 65x102x27
325			29/221-530 TF 24Z 46x50		
325			29/221-531 TC 24Z 46x50 15 paires de pastilles <i>15 pairs of pads</i>		
325			29/221-532 TF 24Z 46x50 renforcé / <i>Strengthened</i>		
Jaguar 100 Laser 90, 100, 110 Léopard 90 turbo Tiger 100 Tiger Six 105	350 DV Valéo	29/200-513 (269.2310.4) (135 0230 30)	350	29/221-517 UC-MH 24Z 46x50 212.2359.3/10 (335 162 30)	29/231-501 MV Lg. 213 mm ⇒20175 (2.2999.207.0) (500 0846 30)
350			29/221-512 UC-LT 24Z 46x50		
350			29/221-528 UF 24Z 46x50 (263.2313.8)	29/231-507 Lg. 224 mm 20176⇒ (202.6551.3) Laser 100 Laser 110 (1280⇒)	
350			29/221-510 UF 24Z 46x50		
350			29/221-511 TF 24Z 46x50 (154.2313.3/10)		
Krypton 80, 90, 100	330 DF	29/200-515 (133 0259 10)	327	29/221-534 TC-LS 24Z 36,5x41,1 (333 0186 10)	
Laser 130, 150, 170 Suite page suivante <i>Continuation on following page</i>	350 DV Valéo	29/200-516 (212.2358.4/10)	350	29/221-517 UC-MH 24Z 46x50 (212.2359.3/10) (335 0162 30)	29/231-501 MV Lg. 213 mm (2.2999.207.0) (500 0846 30)
350			29/221-512 UC-LT 24Z 46x50		
350			29/221-528 UF 24Z 46x50 (263.2313.8)		

Les références des pièces sont indicatives.
Nos pièces ne sont pas d'origine



"THE RELIABLE SERVICE"



Part numbers are quoted for reference purposes only.
Our parts and accessories are not original.

MECANISMES & DISQUES D'EMBRAYAGE
CLUTCH ASSEMBLIES & PLATES

Tracteurs Tractors	Embrayage Clutch		Disque Plate		Butée de débrayage Release Bearing
	Ø	N°	Ø	N°	
Laser 130, 150, 170 Suite de la page précédente <i>Continuation from the previous page</i>	350 DV Valéo	29/200-516 (212.2358.4/10)	350 350	29/221-510 UF 24Z 46x50 29/221-511 TF 24Z 46x50 (154.2213.3/10)	29/231-501 MV Lg. 213 mm (2.2999.207.0) (500 0846 30)
Léone 70 ⇒ Voir / See Centurion 75					
Léopard 85, 90 90T (⇒ 20 174) ⇒ Voir / See Jaguar 95					
Léopard 90 T (20 175 ⇒) ⇒ Voir / See Jaguar 100					
Léopard C, 85C Léopard Crawler	310/310		310 LG 310 LM	29/221-535 UF 20Z 36x40 (331 0172 36) 29/212-514 UF 14Z 22x25 (331 0171 36)	
Mercury 85 ⇒ Voir / See Centurion 75					
Minitauro 60 Minitaurus 60 ⇒ Voir / See Condor 55					
Panther	330 3 doigts 3 levers SAME		325	29/221-536 TF 23Z 44x48	
Panther 90 ⇒ Voir / See Léopard					
Panther 95 ⇒ Voir / See Jaguar 95					
Rock 55, 60 ⇒ Voir / See Argon					
Rock 55, 60, 70 ⇒ Voir / See Argon 60					
Row Crop 90 /DT (⇒1357) ⇒ Voir / See Explorer Top 90 II					

Les références des pièces sont indicatives.
Nos pièces ne sont pas d'origine

Part numbers are quoted for reference purposes only.
Our parts and accessories are not original.



"THE RELIABLE SERVICE"



MECANISMES & DISQUES D'EMBRAYAGE
CLUTCH ASSEMBLIES & PLATES

Tracteurs <i>Tractors</i>	Embrayage <i>Clutch</i>		Disque <i>Plate</i>		Butée de débrayage <i>Release Bearing</i>
	Ø	N°	Ø	N°	
Row Crop 90 (1358 ⇒) ⇒ Voir / See Antares 100					
Same 65 ⇒ Voir / See Explorer 55, 60, 65, 70					
Saturnsynchro 80 ⇒ Voir / See Centurion 75 (3371⇒)					
Silver 80 (⇒ 2073) Silver 90 (⇒ 2963) Silver 100.4 (⇒ 1874) ⇒ Voir / See Explorer 80 II /DT					
Silver 100.6 (⇒ 3222) ⇒ Voir / See Antares 100					
Taurus 60 ⇒ Voir / See Condor 55					
Tiger Six /105 Titan 105, 106 Trident 130 Export	350 DV Valéo	29/200-513 (269.2310.4) (135 0230 30)	350	29/221-537 UF 24Z 46x50 (250.2313.3) (335 0163 36)	29/231-508 MV Lg. 164 mm
	----- 350 3 doigts 3 levers SAME		350	29/221-517 UC-MH 24Z 46x50 (212.2359.3/10) (335 0162 30)	----- 29/231-505 65x102x27
			350	29/221-512 UC-LT 24Z 46x50	
			350	29/221-510 UF 24Z 46x50	
			350	29/221-511 TF 24Z 46x50 (154.2213.3/10)	

AA En option
AN Renforcé
AU Roulement pilote
DF Diaphragme, volant plat
DV Diaphragme, volant creux
G3 3 doigts
GU6 Commande indépendante, 6 doigts
LG Friction d'avancement côté BV, montée
LK Friction prise de force côté BV, montée
LM Friction prise de force côté moteur, libre
LN Friction d'avancement côté moteur, libre
LQ 3 paires de pastilles
LR 4 paires de pastilles
LS 5 paires de pastilles
LT 6 paires de pastilles
MH 7 paires de pastilles
ML 10 paires de pastilles
MV Butée avec support
TC Cera-métallique à ressorts
TF Organique à ressorts
UC Cera-métallique fixe
UF Organique à fixe
VZ Version économique

AA *Optional*
AN *Heavy duty*
AU *Spigot bearing*
DF *Diaphragm, flat flywheel*
DV *Diaphragm, pot flywheel*
G3 *3 levers*
GU6 *Independent clutch, 6 levers*
LG *Main disc, transmission side, mounted*
LK *PTO disc, transmission side, mounted*
LM *PTO disc, engine side, loose*
LN *Main disc, engine side, loose*
LQ *3 pairs of pads*
LR *4 pairs of pads*
LS *5 pairs of pads*
LT *6 pairs of pads*
MH *7 pairs of pads*
ML *10 pairs of pads*
MV *Release bearing with carrier*
TC *Spring cera-metallic*
TF *Spring organic*
UC *Fixed cera-metallic*
UF *Fixed organic*
VZ *Economic version*

Les références des pièces sont indicatives.
Nos pièces ne sont pas d'origine

Part numbers are quoted for reference purposes only.
Our parts and accessories are not original.



MECANISMES & DISQUES D'EMBRAYAGE
CLUTCH ASSEMBLIES & PLATES
LAMBORGHINI

Tracteurs Tractors	Embrayage Clutch		Disque Plate		Butée de débrayage Release Bearing
	Ø	N°	Ø	N°	
C 65	280 DF Valéo	32/200-511 (128 0248 30)	280	32/221-526 TF 24Z 36x40 (328 0275 36)	
C 75	310 DF Valéo	32/200-501 (131 0228 50)	310	32/221-502 TF 24Z 36x40 (331 0179 36)	
C 352	225/225 GA3 Luk	32/200-517 (431.2210.4) (223 0007 11)	225 LG	32/221-540 UF 20Z 36x40 (2.316.746) (323 0035 16)	
			225 LM	32/212-515 UF 13Z 19x22 (431.2222.3) (323 0117 16)	
R 483 /DT	250/230 GU6 Valéo	32/200-518	250 LG	32/221-541 20Z 36x40	
			230 LM	32/212-516 14Z 22x25	
F 660 Plus /DT F 775 Plus /DT F 880 Plus /DT F 990 Plus /DT	280/280 GU6 Luk	32/200-519 (228 0133 10)	280 LG	32/221-508 UC-LT 20Z 36x40 (328 0378 12)	
			280 LM	32/212-517 UC-LQ 14Z 22x25 (328 0377 11)	
C 483, R 483, C 503, R 503, C 553, R 553, C 583, R 583, C 603, C 633, C 654, R 654, C 683, R 683, R 724, R 754, R 754 DT, R 824, R 845 DT, R 854, R 854 DT, R 955, 990 (1975⇒) LUK ET / AND VALÉO NON INTERCHANGEABLE NOT INTERCHANGEABLE Suite à la page suivante <i>Continuation on following page</i>	280/280 GU6 Luk	32/200-509 (171.2252.4/11) (228 0040 13)	280 LG	32/221-514 UF 20Z 36x40 (422.2261.3) (328 0017 16)	32/231-509 50x94x21 32/231-510 70x110x20 (500 0284 00)
			280 LG	32/221-542 UF 20Z 36x40	
			250 LM	32/212-505 UF 14Z 22x25	

 Les références des pièces sont indicatives.
 Nos pièces ne sont pas d'origine

 Part numbers are quoted for reference purposes only.
 Our parts and accessories are not original.

"THE RELIABLE SERVICE"

MECANISMES & DISQUES D'EMBRAYAGE
CLUTCH ASSEMBLIES & PLATES

Tracteurs Tractors	Embrayage Clutch		Disque Plate		Butée de débrayage Release Bearing
	Ø	N°	Ø	N°	
C 483, R 483, C 503, R 503, C 553, R 553, C 583, R 583, C 603, C 633, C 654, R 654, C 683, R 683, R 724, R 754, R 754 DT, R 824, R 845 DT, R 854, R 854 DT, R 955, 990 (1975⇒) LUK ET / AND VALÉO NON INTERCHANGEABLE NOT INTERCHANGEABLE Suite de la page précédente <i>Continuation from the previous page</i>	280/280 GU6 Luk	32/200-508 (171.2250.4) (228 0040 12)	280 LG	32/221-513 UC-LS 20Z 36x40 (328 0017 11)	32/231-509 50x94x21 32/231-510 70x110x20 (500 0284 00)
			280 LM	32/212-506 UF 14Z 22x25 (328 0318 30)	
	280/280 GU6 Valéo	32/200-520	280 LG	32/221-543 UF 20Z 36x40	
			280 LM	32/212-505 UF 14Z 22x25	
	280/280 GU6 Valéo	32/200-507	280 LG	32/221-513 UC-LS 20Z 36x40 (328 0017 11)	
			280 LG	32/221-544 UF 20Z 36x40	
280 LM			32/212-506 UF 14Z 22x25 (328 0318 30)		
			280 LM	32/212-518 UF 14Z 22x25	
R 674 (⇒1970)	280 Diaphr. B. & B 8 goujons 8 studs	32/200-512 (128 0243 50)	280	32/221-526 TF 24Z 36x40 (328 0275 36)	32/231-500 55x91x26 (500 0076 20)
C 635, R 573, R 674	280 Diaphr. Valéo 6 goujons 6 studs	32/200-511 (128 0248 30)	280	32/221-526 TF 24Z 36x40 (328 0275 36)	
R 704, R 804	280/280 GU6 Luk	32/200-521 (427.2410.4/10) (228 0068 10)	280 LG	32/221-545 UC-LT 23Z 44x48 (4.272.851) (328 0093 10)	32/231-509 50x94x21 32/231-510 70x110x20 (500 0284 00)
			280 LM		

Les références des pièces sont indicatives.
Nos pièces ne sont pas d'origine



"THE RELIABLE SERVICE"



Part numbers are quoted for reference purposes only.
Our parts and accessories are not original.

MECANISMES & DISQUES D'EMBRAYAGE
CLUTCH ASSEMBLIES & PLATES

Tracteurs Tractors	Embrayage Clutch		Disque Plate		Butée de débrayage Release Bearing
	Ø	N°	Ø	N°	
R 704, R 754, R 784, 845 DT, 854 DT, R 955 /DT	310/310 3 doigts 3 levers		310 LG	32/221-535 UF 20Z 36x40 (331 0172 36)	
	Diaphr. Valéo		310 LG	32/221-546 UC-LT 20Z 36x40	
			310 LM	32/212-514 UF 14Z 22x25 (331 0171 36)	
R 774-80 Grand Prix, R 874-90 Grand Prix, R 974-90 Grand Prix	310 DF Diaphr. B. & B	32/200-501 Ø Ext. / Out 365 mm (131 0228 50)	310	32/221-501 TC-LT 24Z 36x40 (331 0184 30)	32/231-500 55x91x26 (500 0076 20)
	310 DF Diaphr. Valéo	32/200-500 Ø Ext. / Out 368 mm (131 0229 30)	310	32/221-502 TF 24Z 36x40 (331 0179 36)	
R 904	330/310 GU6 Luk	32/200-522 (429.2453.4) (233 0004 10) Remplace ancien modèle Walterscheid <i>Replaces old Walterscheid clutch</i>	330 LG	32/221-547 UC-LT 23Z 44x48 (429.2451.4) (333 0004 10)	32/231-511 65x97 (500 0059 10) 32/231-512 75x115x20 (500 0378 00)
			310 LM	32/212-519 UF 16Z 27x30	
			310 LG	32/221-547 UC-LT 23Z 44x48 (429.2451.4) (333 0004 10)	
			310 LM	32/212-514 UF 14Z 22x25 (195.2222.3) (331 0171 36)	
R 956 /DT R 1056 /DT R 1106 /DT R 1156 /DT R 1256 DT R 1306 /DT R 1356 /DT R 1556 /DT	350 DV Valéo	32/200-513 (135 0230 30)	350	32/221-517 UC-MH 24Z 46x50 (212.2359.3/10) (335 0162 30)	32/231-508 MV Lg. 164 mm
			350	32/221-510 UF 24Z 46x50	
			350	32/221-532 TF 24Z 46x50	

 Les références des pièces sont indicatives.
 Nos pièces ne sont pas d'origine

 Part numbers are quoted for reference purposes only.
 Our parts and accessories are not original.

"THE RELIABLE SERVICE"

MECANISMES & DISQUES D'EMBRAYAGE
CLUTCH ASSEMBLIES & PLATES

Tracteurs Tractors	Embrayage Clutch		Disque Plate		Butée de débrayage Release Bearing
	Ø	N°	Ø	N°	
R 1306 Turbo R 1506 Turbo	350 DV Valéo	32/200-513 (135 0230 30)	350 350 350	32/221-517 UC-MH 24Z 46x50 (212.2359.3/10) (335 0162 30) 32/221-510 UF 24Z 46x50 32/221-532 TF 24Z 46x50	32/231-508 MV lg. 213 mm
R 1706 Turbo	350 DV Valéo	32/200-513 (135 0230 30)	350 350 350	32/221-517 UC-MH 24Z 46x50 (212.2359.3/10) (335 0162 30) 32/221-510 UF 24Z 46x50 32/221-532 TF 24Z 46x50	
Formula 105	310 DV Valéo 310 DV B. & B.	32/200-500 Ø Ext. / Out. 368 mm (131 0229 30) 32/200-501 Ø Ext. / Out. 365 mm (131 0228 50)	310 310	32/221-501 TC-LT 24Z 36x40 (331 0184 30) 32/221-502 TF 24Z 36x40 (331 0179 36)	32/231-500 55x91x26 (500 0076 20)
Formula 105 Formula 115 (⇒ 3129) Formula 125 Formula 135	330 DV Valéo	32/200-502 (133 0220 30)	330	32/221-503 TC-LT 24Z 36,5x41 (333 0116 30)	32/231-501 MV Lg.213mm (500 0846 30)
Formula 135	350 DV Luk 350 Valéo DV	32/200-503 (135 0241 10) 32/200-513 (135 0230 30)	348 350	32/221-506 TC-LT 21Z 41x45 (335 0186 10) 32/221-517 UC-MH 24Z 46x50 (212.2359.3/10) (335 0162 30)	32/231-501 MV Lg.213mm (500 0846 30)
N Cross 674-70	310 DF Valéo	32/200-500 Ø Ext. / Out. 368 mm (131 0229 30)	310	32/221-501 TC-LT 24Z 36x40 (331 0184 30)	32/231-500 55x91x26 (500 0076 20)

Les références des pièces sont indicatives.
Nos pièces ne sont pas d'origine



"THE RELIABLE SERVICE"



Part numbers are quoted for reference purposes only.
Our parts and accessories are not original.

MECANISMES & DISQUES D'EMBRAYAGE
CLUTCH ASSEMBLIES & PLATES

Tracteurs Tractors	Embrayage Clutch		Disque Plate		Butée de débrayage Release Bearing
	Ø	N°	Ø	N°	
Premium 150 (⇒ 1433) Premium 160 (⇒ 2077) Premium 850 Premium 950	330 DF	32/200-502 (008.4184.3) (133 0220 30)	330	32/221-503 TC-LT 24Z 36,5x41 (009.6533.3) (333 0116 30) 32/221-504 TF 24Z 36,5x41 (008.9937.3) (333 0117 30)	32/231-501 MV Lg.213mm (500 0846 30)
Sprint 664-60 Sprint 674-70	310 DF Valéo	32/200-500 Ø Ext. / Out. 368mm (131 0229 30)	310	32/221-501 TC-LT 24Z 36x40 (331 0184 30)	32/231-500 55x91x28 (500 0076 20)

DF Diaphragme, volant plat
 DV Diaphragme, volant creux
 G3 3 Doigts
 GA6 Commande combinée, 6 doigts
 GU6 Commande indépendante, 6 doigts
 LG Friction d'avancement côté BV, montée
 LM Friction prise de force côté moteur, libre
 LQ 3 paires de pastilles
 LS 5 paires de pastilles
 LT 6 paires de pastilles
 MH 7 paires de pastilles
 MV Butée avec support
 TC Cera-métallique à ressorts
 TF Organique à ressorts
 UC Cera-métallique fixe
 UF Organique fixe

DF Diaphragm, flat flywheel
 DV Diaphragm, pot flywheel
 G3 3 levers
 GA6 Combined clutch, 6 levers
 GU6 Independent clutch, 6 levers
 LG Main disc, transmission side, mounted
 LM PTO disc, engine side, loose
 LQ 3 pairs of pads
 LS 5 pairs of pads
 LT 6 pairs of pads
 MH 7 pairs of pads
 MV Release bearing with carrier
 TC Spring cera-metallic
 TF Spring organic
 UC Fixed cera-metallic
 UF Fixed organic

Les références des pièces sont indicatives.
Nos pièces ne sont pas d'origine

Part numbers are quoted for reference purposes only.
Our parts and accessories are not original.

"THE RELIABLE SERVICE"

MECANISMES & DISQUES D'EMBRAYAGE
CLUTCH ASSEMBLIES & PLATES
HÜRLIMANN

Tracteurs Tractors	Embrayage Clutch		Disque Plate		Butée de débrayage Release Bearing
	Ø	N°	Ø	N°	
H 355, H 360 H 470, H 476 H 480, H 481 LUK ET / AND VALÉO NON INTERCHANGEABLE NOT INTERCHANGEABLE	280/280 GU6 Luk	33/200-508 (228 0040 12)	280 LG	33/221-513 UC-LS 20Z 36x40 (328 0017 11)	33/231-509 50x94x21 33/231-510 70x110x20 (500 0284 00)
			280 LM	33/212-518 UF 14Z 22x25	
	280 LM	33/212-506 UF 14Z 22x25 (328 0318 30)			
	280 LG	33/221- 548 UF 20Z 36x40			
H 356, H 358, H 466, H 468	280 Diaphr. B. & B. 8 goujons 8 studs	33/200-512 (128 0243 50)	280	33/221-526 TF 24Z 36x40 (328 0275 36)	33/231-500 55x91x26 (500 0076 20)
	ou / or 280 Diaphr. Valéo 6 goujons 6 studs	33/200-511 (128 0248 30)			
H 480	310/310 3 doigts 3 levers Diaphr. Valéo		310 LG	33/221-546 UC-LT 20Z 36x40	
			310 LM	33/212-514 UR 14Z 22x25 (331 0171 36)	
H 476, H 478, H 488 B. & B. ET / AND VALÉO NON INTERCHANGEABLE NON INTERCHANGEABLE	310 DF Diaphr. B. & B.	33/200-501 Ø Ext. / Out. 365 mm (131 0228 50)	310	33/221-501 TC-LT 24Z 36x40 (331 0184 30)	33/231-500 55x91x26 (500 0076 20)
	310 DF Diaphr. Valéo	33/200-500 Ø Ext. / Out. 368 mm (131 0229 30)		33/221-502 TF 24Z 36x40 (331 0179 36)	

Les références des pièces sont indicatives.
Nos pièces ne sont pas d'origine



"THE RELIABLE SERVICE"



Part numbers are quoted for reference purposes only.
Our parts and accessories are not original.

MECANISMES & DISQUES D'EMBRAYAGE
CLUTCH ASSEMBLIES & PLATES

Tracteurs Tractors	Embrayage Clutch		Disque Plate		Butée de débrayage Release Bearing
	Ø	N°	Ø	N°	
H 490 H496T H5116 H 5160 H 6160 H 6170	350 DV Valéo	33/200-513 (135 0230 30)	350 350	33/221-517 UC-MH 24Z 46x50 (335 0162 30) 33/221-510 UF 24Z 46x50	33/231-508 MV Lg. 164 mm
H 490 H 5160 H 6160	350 Origine		350 350	33/221-517 UC-MH 24Z 46x50 (335 0162 30) 33/221-510 UF 24Z 46x50	
H 6135 XB Elite	350 DV LuK	33/200-503 (135 0241 10)	348	33/221-506 TC-LT 21Z 41x45 (335 0186 10)	33/231-501 MV Lg.213mm (500 0846 30)
XA 607	310 DF	33/200-501 (131 0228 50)	310	33/221-502 TF 24Z 36x40 (331 0179 36)	33/231-500 55x91x26 (500 0076 20)
XT910.6	330 DV Valéo	33/200-502 (133 0220 30)	330	33/221-503 TC-LT 24Z 36,5x41 (333 0116 30)	33/231-501 MV Lg.213mm (500 0846 30)
H6115 XT909 XT910.4	330 DV Valéo	33/200-502 (133 0220 30)	330	33/221-504 TF 24Z 36,5x41 (333 0117 30)	

DF Diaphragme, volant plat
 DV Diaphragme, volant creux
 GU6 Commande indépendante, 6 doigts
 LG Friction d'avancement côté BV, montée
 LM Friction prise de force côté moteur, libre
 LS 5 paires de pastilles
 LT 6 paires de pastilles
 MH 7 paires de pastilles
 MV Butée avec support
 TC Cera-métallique à ressorts
 TF Organique à ressorts
 UC Cera-métallique fixe
 UF Organique fixe

DF Diaphragm, flat flywheel
 DV Diaphragm, pot flywheel
 GU6 Independent clutch, 6 levers
 LG Main disc, transmission side, mounted
 LM PTO disc, engine side, loose
 LS 5 pairs of pads
 LT 6 pairs of pads
 MH 7 pairs of pads
 MV Release bearing with carrier
 TC Spring cera-metallic
 TF Spring organic
 UC Fixed cera-metallic
 UF Fixed organic

Les références des pièces sont indicatives.
Nos pièces ne sont pas d'origine

Part numbers are quoted for reference purposes only.
Our parts and accessories are not original.

"THE RELIABLE SERVICE"

MAITRE CYLINDRE & CYLINDRE RECEPTEUR D'EMBRAYAGES
MASTER & SLAVE CYLINDERS (CLUTCHES)

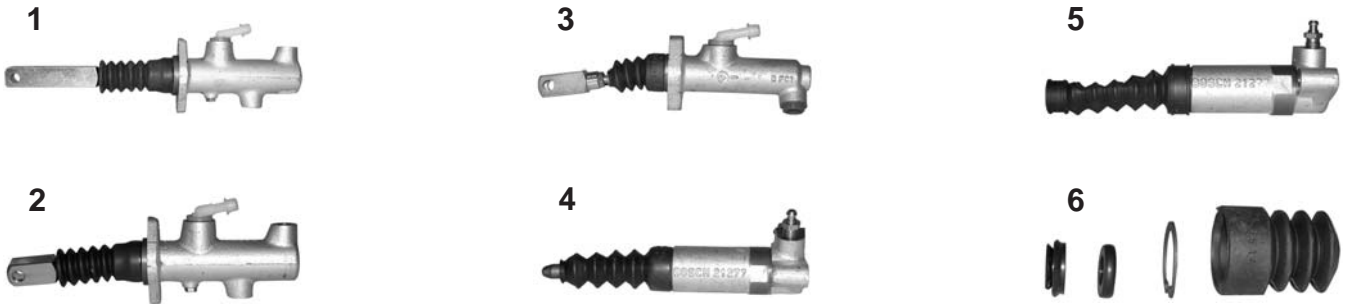

	Fig. Fig.	Réf. Ref.	OEM OEM	Désignation Description
Premium 850, 950, 1050, 1060, 1100, 1300 Formula 115, 135 XT908, 909, 910-4, 910-6, 911, 913 Elite XB 6115, 6135 Antares 110, 130 II Row crop 100.6 Silver 80, 90, 100-4, 100-6, 110, 130	1	29/008-2753	0.008.2753.4/10	Maître cylindre Master cilinder
Laser 100, 110, 130, 160 956, 956-100, 1106, 1306, 1506	2	29/257-6538-4	257.6538.4/10	Maître cylindre Master cilinder
574-60N, 674-70N, 674-70N B, 674-70N, 774-80N Grand prix 674-70, 774-80, 874-90T High clearance 90 Sprint 654-55, 664-60, 664-65, 674-70, 675-75 H358, H468, H478, H484T P, H358-4, H468-4, H468-4B C Prestige H478, H488T H478-4 XA606, XA607, XA655, XA656T, XA657, XA658 Explorer II 60, 70, 80, 90T	3	S.255/6538	0.255.6538.4/50	Maître cylindre Master cilinder
574-60N, 674-70N, 674-70N B, 674-70N, 774-80N Grand prix 674-70, 774-80, 874-90T High clearance 90 Premium 850, 950, 1050, 1060, 1100, 1300 Formula 115, 135 Prestige H-358, H468, H-478, H-488T Antares 110, 130 II Explorer 60, 70 Explorer 60, 70, 80 Basso Explorer 80 SKD Explorer 60, 70, 80, 90T Explorer special 70, 80, 90-8 Row crop 90, 100, 100.6 Silver 80, 90, 100-4, 100-6, 110, 130	4	29/255-6537	0.255.6537.4/60	Cylindre récepteur Slave cilinder
956DT, 956-100, 1106, 1306, 1506 Laser 100, 110, 130, 150 Laser transporter 85	5	S.257/6537	0.257.6537.4/40	Cylindre récepteur Slave cilinder
H358, H468, H478, H488T P, H358-4, H468-4, H468-4B C, H478-4 XA606, XA607, XA655, XA656T, XA657, XA658 574-60N, 674-70N, 674-70N B Grand prix 674-70, 774-80, 874-90T 674-70N, 774-80N High clearance 90 Sprint 654-55, 664-60, 664-65, 674-70, 675-75 Explorer II 60, 70, 80, 90T	6	29/255-6538-6	0.255.6538.6	Kit réparation du cyl. récepteur Repair kit of Slave cilinder
956-100, 1106, 1306, 1506 Laser 100, 110, 130, 150 Laser Transporter 85	6	29/235-6557	0.235.6557.6	Kit réparation du maître cyl. Repair kit of master cilinder



PIECES DETACHEES POUR EMBRAYAGES VALEO
REPLACEMENT PARTS FOR VALEO CLUTCHES

Embrayage / Clutch 29/M.226 (171.2252.4)

Lamborghini :R.653, 654, 684

Hürlimann : H.355, 360, 470

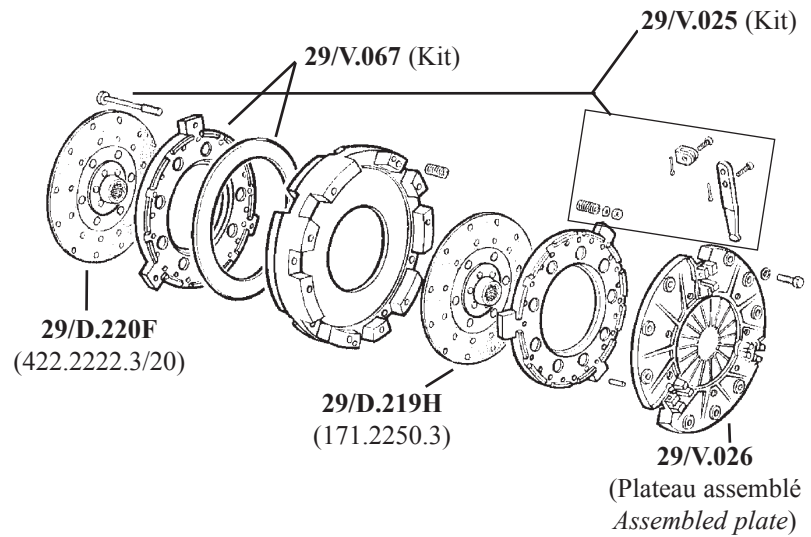

29/V.016 (Kit)

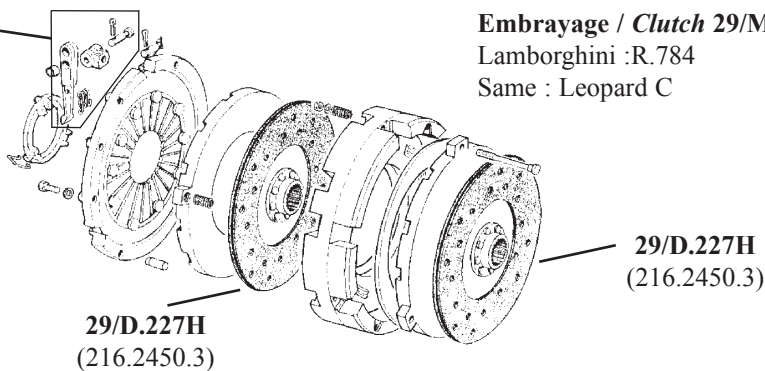

Embrayage / Clutch 29/M.229 (195.2210.4)

Lamborghini :R.955, 784

Hürlimann : H.480

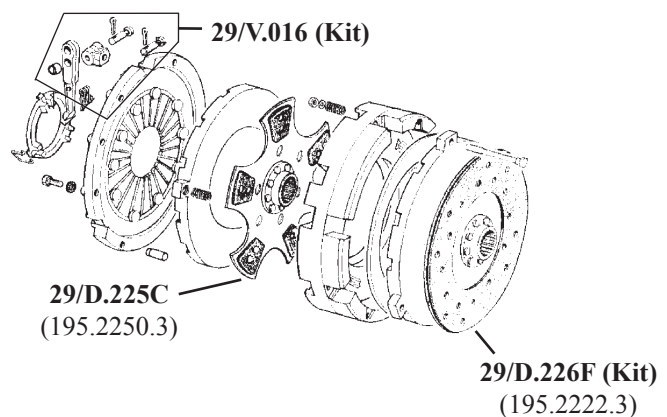

Les références des pièces sont indicatives.
Nos pièces ne sont pas d'origine

Part numbers are quoted for reference purposes only.
Our parts and accessories are not original.



COMMANDE DE PRISE DE FORCE
PTO DRIVE

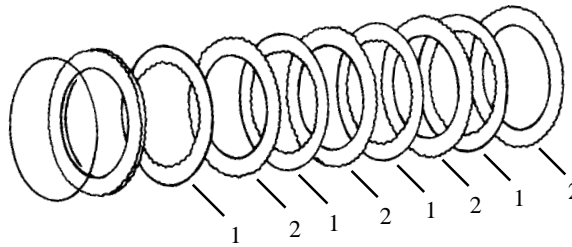

Tracteurs Tractors	Fig. Fig.	PTO	Dents Teeth
Buffalo 120, 130 Exp., Galaxy170 Turbo, Hercules 160 Exp.	1	29/164-3642	45
	2	29/164-3643	54
Jaguar 95 Exp., Laser 90, 100, 110, Leopard 85, 90, Panther 95, Tiger 100, Tiger Six 105 Exp.	1	29/163-3654	52
	2	29/163-3655	60
Explorer 65C, 70C Ergomatic, 75C	1	29/292-5714	62
	2	29/292-5715	87
Explorer 55, 60, 65 Spécial, 70, 75, 80, 90	1	29/255-3970	48
	2	29/255-3936	

ARBRE DE PRISE DE FORCE
PTO SHAFTS

Type long / Long type

S.136/3612 (13636123) Type long - 1 3/8" - 6 cannelures
Long type - 1 3/8" - 6 splines
Centaurus, Centurion, Corsaro, Leone, Drago, Saturno

S.146/3612 (14636123) **NEW** Taurus 60 Export, Minitauro, Falcon, Minitaurus

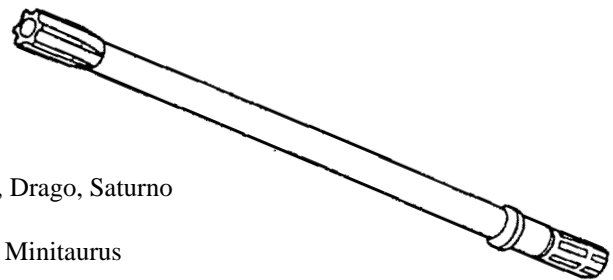

Type à plateau / Plate type

S.167/3660 (16736600/30) 1 3/8" - 6 cannelures / splines
Antares 100, 110, 130, Aster 60, 70, Titan 145, 160, Explorer II 60, 70, Leopard,
Jaguar 95, Export, Buffalo 130, Tiger 100, Laser100, 130, Tiger Six 105

S.167/3661 (16736610/20) 1 3/4" - 6 cannelures / splines
Buffalo, Tiger 100, Explorer II 60, 70

S.163/3671 (16336710/40) **NEW** 1 3/8" - 21 cannelures / splines
Antares 100, 110, 130, Aster 60, 70, Explorer II 60, 70, Laser,
Leopard, Titan, Tiger Six 105, Panther

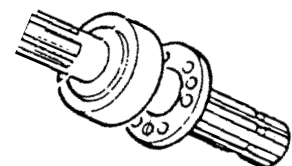

Les références des pièces sont indicatives.
Nos pièces ne sont pas d'origine.

Part numbers are quoted for reference purposes only.
Our parts and accessories are not original.

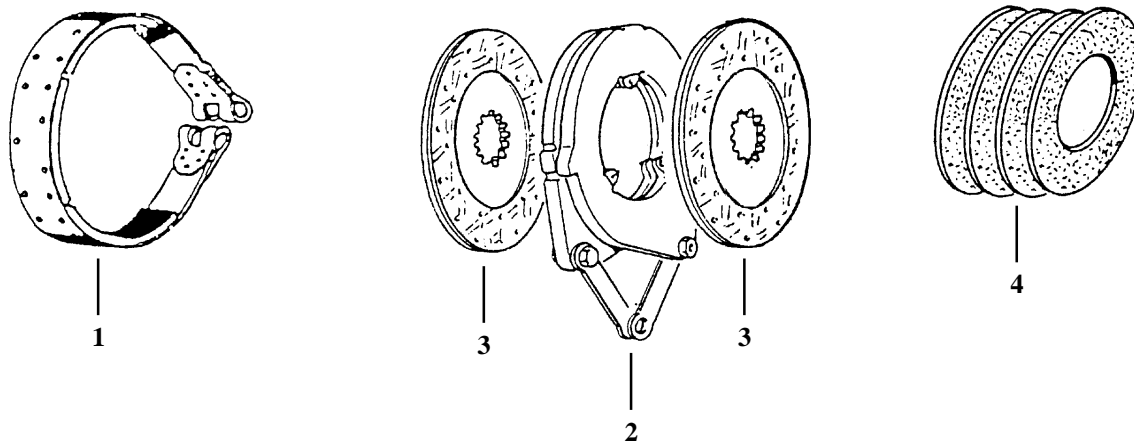

FREINAGE
BRAKES

Tracteurs Tractors	Fig. Fig.	Réf. Ref.	OEM	Ø Ext. (mm) Outer Ø (mm)	Cannelures Splines	Ø cannel. (mm) Splines Ø (mm)
FREINS A BANDE / BRAKE BAND						
Same Centaurio 55, 60, 65 Corsaro 70, 70 synchro	1	S.157/5411	15754113/10	250		
Same Falcon, Minitauro 50, 55, 60 Frutteto, 60 Vigneto		S.146/5411	14654113/20	225		
FREINS A DISQUES SECS / BRAKE DISCS (DRY)						
Same Aurora 35,45, Sirenetta Vigneron 35,45, Delfino	2	S.159/5432	15954323	102		
Lamborghini R235, 235DT, 235S	3	S.151/5450	15154503		23	28x31
Same Centurion 75 Export Condor 55 synchro (↔ N.10000) Corsaro 70, 70 synchro Corsaro Frutteto Minitaurus 60 synchro (↔ 53753) Saturno, Saturno 80 synchro Taurus 60 Export	2	S.136/5432K	13654323	178		
	3	S.158/5434	15854343		13	38 x 44
Lamborghini R483, 483DT (N.1149 ↔) R503, 503DT, R603, 603DT (82 ↔) R583, 583DT, R653, 653DT R654, 654DT, R653 Frutteto R683, 683DT, R684, 684DT R684DT Frutteto, R724, 724DT	2	S.136/5432K	13654323			
	3	SLT.177/5434	17754343		23	44 x 48
Hürlimann H345, H355, H360 (↔ N.00626)	4	S.136/5435K	13654350			

Les références des pièces sont indicatives.
Nos pièces ne sont pas d'origine.

Part numbers are quoted for reference purposes only.
Our parts and accessories are not original.



**FREINAGE
BRAKES**

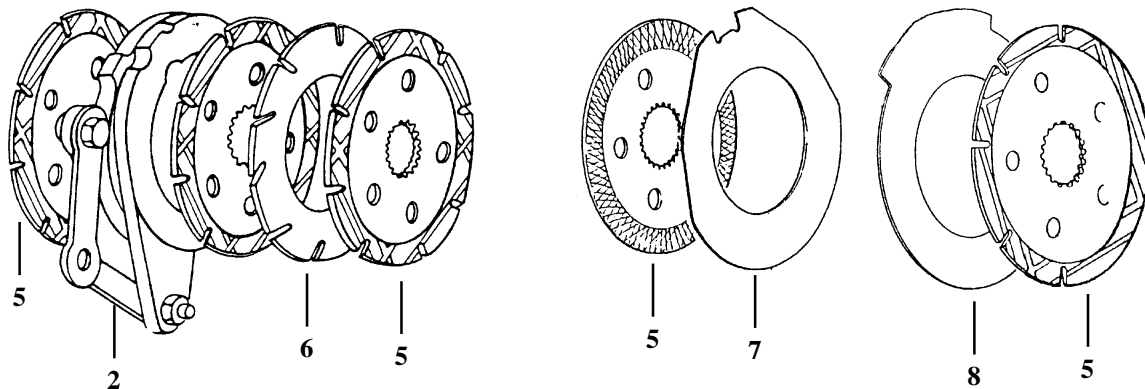

Tracteurs Tractors	Fig. Fig.	Réf. Ref.	OEM	Ø Ext. (mm) Outer Ø (mm)	Cannelures Splines	Ø cannel. (mm) Splines Ø (mm)
FREINS A DISQUES SOUS HUILE A COMMANDE MECANIQUE BRAKE DISCS (OIL BATH)(MECHANICAL)						
Same Buffalo 120, 130 Export Drago 100, 120 Hercules 160 Export (⇔ N.1240) Panther 95 Lamborghini R360, 360DT, R365, 365DT R470, 470DT, R475, 475DT Hürlimann H5160, H6160, H6170T (⇔ N.00161) Roue arrière/Rear wheel	2	S.154/5461K				
	5	S.154/5459	15454590	224	27	55 x 61
	6	S.154/5460	15454600	228		Ø int./inn 127
Lamborghini R704, 704DT R804, 804DT, R904, 904DT Hürlimann R480, 480DT, R485, 485DT, R490	2	SLT.427/5461K				
	5	SLT.427/5454	42754340	224	22	53 x 60
	7	SLT.427/5455	42754550	228		Ø int./inn 127
Same Condor 55 synchro (1001 ⇔) Explorer 60 II & 60 special Minitaurus 60 Frutteto Minitaurus 60 synchro (N.53754 ⇔)	5	S.194/5464	19454642	178	13	38 x 45
	8	S.194/5465	19454650	184		Ø int./inn 125
FREINS A DISQUES SOUS HUILE A COMMANDE HYDRAULIQUE BRAKE DISCS (OIL BATH)(HYDRAULIC)						
Same Centauro 70 special Centurion 75 special Hercules 160 Export (N.1241 ⇔) Galaxy 170 Turbo Roue arrière/Rear wheel Mercury 85 special Hürlimann H6130, H5160, H6160, H6170T (N.00162 ⇔) Roue arrière/Rear wheel	5	S.154/5459	15454590/10	224	27	55 x 61
	6	S.154/5460	15454600/10	228		Ø int./inn 127

Les références des pièces sont indicatives.
Nos pièces ne sont pas d'origine.

Part numbers are quoted for reference purposes only.
Our parts and accessories are not original.



**FREINAGE
BRAKES**

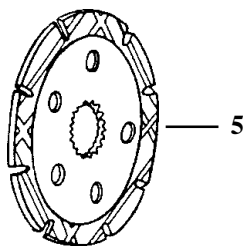

Tracteurs Tractors	Fig. Fig.	Réf. Ref.	OEM	Ø Ext. (mm) Outer Ø (mm)	Cannel. Splines	Ø cannel. mm Splines Ø (mm)
FREINS A DISQUES SOUS HUILE / BRAKE DISCS (OIL BATH)						
Same (Roue arrière / <i>Rear wheels</i>) Jaguar 95 Export Laser 90, 100, 110, 130, 150T Leopard 85 Export, 90 Turbo Tiger 100, Tiger Six 105 Export Trident 130 Export Titan 145, 160, 190	5	S.170/5434	17054340	304	12	51 x 68
Lamborghini (Roue arrière / <i>Rear wheels</i>) R956, R956-100, R1106 R1056, R1306 Turbo DT, R1356DT R1506DT Turbo, A1556 DT						
Hürlimann (Roue arrière / <i>Rear wheels</i>) H490, H496T, H5110 H6136, H6165 Master, H6190 Master						
Same (Roue arrière / <i>Rear wheels</i>) Explorer 55, 60 Explorer 60 II, 60 Special, 65, 65 Special 70 II, 70 Special, 70 II Special		29/255-5447	25554472/10	282	13	46 x 59
Lamborghini (Roue arrière / <i>Rear wheels</i>) R573-60N, R574-60N, R674, R674-5 R674-70N, R674-70 Grand Prix						
Hürlimann (Roue arrière / <i>Rear wheels</i>) H356, H358, H358-4 Club H358 Prestige, H466, H468						
Same (Roue arrière / <i>Rear wheels</i>) Explorer 75, 80II, 80 Special, 80 II Special 90 II Turbo Silver 80, 90, 100-4, 100-6		29/445-5447	44554472/10 00970672	282	12	46 x 59
Lamborghini (Roue arrière / <i>Rear wheels</i>) R774, 774DT, 774-5, 774-80, 774-80N 774-80 Grand Prix, 874 Turbo 874-90T Grand Prix, 674-70 Grand Prix Premium 850, 950, 1050, 1060						
Hürlimann (Roue arrière / <i>Rear wheels</i>) H476, H478, H486, H488 H6115 Elite, H6135 Elite						

Les références des pièces sont indicatives.
Nos pièces ne sont pas d'origine.

Part numbers are quoted for reference purposes only.
Our parts and accessories are not original.



**FREINAGE
BRAKES**

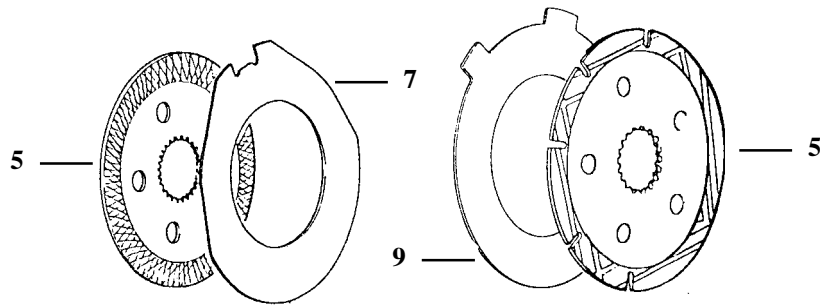

Tracteurs Tractors	Fig. Fig.	Réf. Ref.	OEM	Ø Ext. (mm) Outer Ø (mm)	Cannel. Splines	Ø cannel. (mm) Splines Ø (mm)
FREINS A DISQUES SOUS HUILE / BRAKE DISCS (OIL BATH)						
Same Frutteto 60, 75, Solar 50, 60, Vigneron 75	5	SLT.256/5434	25654340/10 25654340	178	23	44 x 48
Lamborghini R483, 483DT, R550, 550DT, R583, 583DT, R653, 653DT, R654, 654DT, R653 Frutteto, R683, 683DT, R684, 684DT, R684 Frutteto, R724, 724DT, 660, 660DT, 660F, 660V, 775, 775F	7	SLT.256/5436	25654560 17754750	184		Ø int./inn 114
Hürlimann H351, H355F, H360 (N.00811↔) H470 (N. 00627↔), H361, H476F						
Lamborghini R1156, R1256		SLT.188/5434	18854340	342		58 x 83
Lamborghini R754, 754DT, R955, 955DT R784, 784DT, R854, 854DT		SLT.171/5434	17154342	260	12	51 x 68
Hürlimann H480	5					
Same (Roue avant / Front whell) Centauro Export, Centurion 75 Special Explorer 65, 65 Special & 70 II Explorer 75, 80 II, 80 Special, 80 II Special Galaxy 170 Turbo, Laser 90, 100, 110, 130, 150T Silver 80, 90, 100-4, 100-6, Antares 100, 110, 130 Titan 145, 160, 190		S.224/5434	22454340	224	27	55 x 61
Lamborghini (Roue avant / Front whell) R774, 674, R956, R956-100, R1106, R1106DT R1306 Turbo DT, R1356DT, R1506 Turbo DT R1556DT, R1706 Turbo DT, Formula 115, 135, Grand Prix 674-90, 774-80, Grand Prix 874-90T Premium 850, 950, 1050, 1060 Racing 150, 165, 190	9	S.275/4351	27543510	228		Ø int. /inn 140
Hürlimann (Roue avant / Front whell) H496T, H466, 468, 476, 478, 486, 488 H6136, H6115 Elite, H6135 Elite H6165 Master, H6190 Master						
Hürlimann H5160, 6160, 6170T (Roue avant & arrière/ Front & rear whell)						

Les références des pièces sont indicatives.
Nos pièces ne sont pas d'origine.

Part numbers are quoted for reference purposes only.
Our parts and accessories are not original.



**FREINAGE
BRAKES**

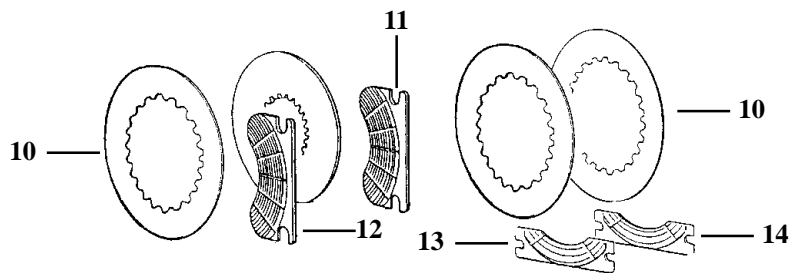

Tracteurs Tractors	Fig. Fig.	Réf. Ref.	OEM	Ø Ext. (mm) Outer Ø (mm)	Cannelures Splines	Ø cannel. Splines Ø (mm)
FREINS DE STATIONNEMENT / HANDBRAKE DISCS						
Lamborghini R573, R574, R674 R674-70 Grand Prix, R774, R874 774-80, 874-90T Premium 850, 950	10	29/255-5452	25554520	150	19	59 x 68
	11	29/224-5451	17154512	Simple Singles		
	12	29/224-5459	17154592	Double Double		
Same Jaguar95 Export (N.5131 ⇄) Laser 90, 100, 110, 130, 150 Turbo Leopard 90 Turbo, Tiger 100 Tiger Six 105 Export, Trident 130 Export	10	S.188/5458	18854580	185	26	64 x 70
	11	29/224-5451	17154512	Simple Singles		
	12	29/224-5459	17154592	Double Double		
Lamborghini R956, R1106, R1056, R1256, R1156, R1306, R1356, R1506, R1556	10	S.171/5457	17154570	170	26	64 x 70
	11	29/224-5451	17154512	Simple Singles		
	12	29/224-5459	17154592	Double Double		
Hürlimann H355, H360, H470, H480	10	S.171/5457	17154570	170	26	64 x 70
	11	29/224-5451	17154512	Simple Singles		
	12	29/224-5459	17154592	Double Double		
Same Antares 100, 110, 130, Aster 60, 70	11	29/224-5451	17154512	Simple Singles		
	12	29/224-5459	17154592	Double Double		
Lamborghini Formula 115, 135 Plus 660F, 775F, 880F 990F Premium 1050, 1060	11	29/224-5451	17154512	Simple Singles		
	12	29/224-5459	17154592	Double Double		
Hürlimann H6115 Elite, H6135 Elite	11	29/224-5451	17154512	Simple Singles		
	12	29/224-5459	17154592	Double Double		
Same Centaurio 70 Export, 70 Special Centurion 75 Special Mercury 85 Export, 85 Special	10	29/224-5464	22454640/20	165	25	104 x 115
	13	29/224-5458	22454580/10	Simple Singles		
	14	29/224-5465	22454650/10	Double Double		

Les références des pièces sont indicatives.
Nos pièces ne sont pas d'origine.

Part numbers are quoted for reference purposes only.
Our parts and accessories are not original.



**FREINAGE
BRAKES**

**MAITRE CYLINDRES DE FREIN
MASTER CYLINDER (BRAKE)**

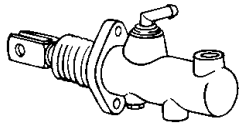

Tracteurs Tractors	Emetteur Master	Kit réparation Repair Kit
Antares	29/008-2190 (x2)	
Explorer Laser	29/257-6638 (x2)	
Centauro Jaguar Leopard Panther Tiger, Tiger Six	S.169/6665	29/169-6665

**CABLES DE FREIN
BRAKE CABLES**

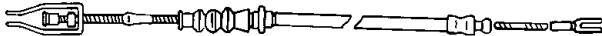

S.170/6670	Lg. : 1005mm	Tiger
S.174/6650	Lg. : 560mm	Buffalo
29/202-6625	Lg. : 760mm	Tiger Six
S.264/6636 (26466360)	Lg. : 825mm	Laser

**RESERVOIR HUILE DE FREIN
OIL BRAKE TANK**

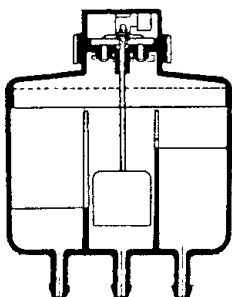

S.257/6654
(25766544/10)

Antares 100, 110, 130
Laser 110
Explorer II 60, 70, 80, 90

**GOUJONS & ECROUS DE ROUES
STUDS & NUT WHEEL**



S.135/4737A	Ø 20x52mm Ariete, Drago, Panther, ... H456
S.1011/311	Ecrou dito Nut for dito
S.146/4737X	Ø 16x37mm Minitauro, Minitaurus, Taurus
S.1099/016	Ecrou dito Nut for dito
S.148/4737	Ø 20x64mm Corsaro, Centurion, Leopard, Tiger, Saturno, ...
S.1011/311	Ecrou dito Nut for dito

**VIS DE ROUES AVANTS
SCREWS (FRONT WHEEL)**

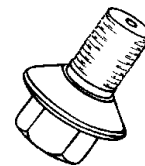

S.399/003	Ø 20x25mm Suivant montage 2 & 4 RM Some applications 2 & 4 WD
S.399/018	Ø 18x19mm Suivant montage 2 & 4 RM Some applications 2 & 4 WD
S.399/020	Ø 16x16mm Suivant montage 2 & 4 RM Some applications 2 & 4 WD

Les références des pièces sont indicatives.
Nos pièces ne sont pas d'origine.

Part numbers are quoted for reference purposes only.
Our parts and accessories are not original.



TRANSMISSION
TRANSMISSION

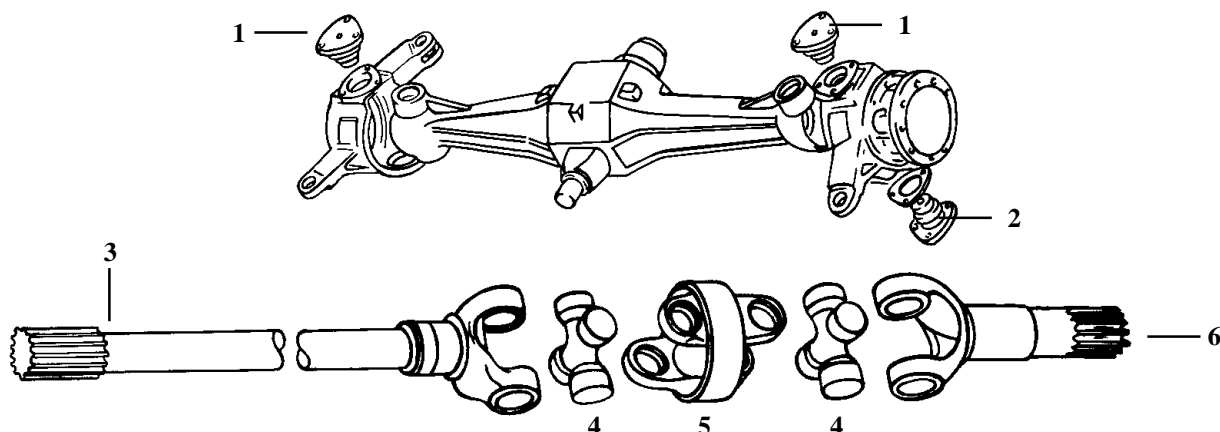

Tracteurs Tractors	Fig. Fig.	Référence Reference		Ømm Ømm	OEM
Saturno, Minitauro, Falcon	1	S.135/4335	NEW		13543350
Drago, Buffalo, Panther	2	S.135/4367	NEW		13543670
		S.148/4337			14843370/10
Saturno, Mercury, Centurion, Leopard, Corsaro	3	S.135/4630	NEW		13546300/20
Taurus, Minitauro, Minitaurus, Falcon		S.146/4630		14646300/20	
Jaguar, Panther		S.148/4630		14846300/10	
Trident 130, Drago, Buffalo, Tiger 100, Tiger Six 105		S.154/4630			15446300/10
Falcon, Minitaurus, Minitauro, Taurus, Explorer, Aurora, Titan, Aster, Antares 110, 130 Hürlimann : H.360	4	S.146/4632		23,8x61	14646326/10
Saturno, Trident 130, Mercury, Drago, Centurion, Leopard, Jaguar, Buffalo, Panther, Aurora, Corsaro, Tiger 100, Tiger Six 105		S.150/4632		27x82	15046326/20
Laser		29/258.4632		30,2x92	2584632/10
Titan		S.212/4632		30,5x107	2124632/10
Mercury, Leopard, Jaguar, Panther, Corsaro	5	S.135/4633	NEW		13546330/05
Taurus, Minitauro, Minitaurus, Falcon		S.146/4633		14646330	
Aurora, Tiger 100, Buffalo, Trident, Explorer II, Antares 100, Drago, Tiger Six 105 Lamborghini : 774, 874		S.150/4633		15046330/10	
Aster 60, 70		S.270/4633		27046330/20	
Saturno, Corsaro	6	S.135/4634	NEW	Z = 17	13546340/08
Saturno, Mercury, Centurion, Leopard, Corsaro		S.136/4634		Z = 16	13646340/20
Taurus, Minitaurus, Falcon		S.146/4634			14646340/30
Drago		S.154/4634		Z = 13	15446340/06
Buffalo, Tiger, Tiger Six 105, Tiger 100		S.164/4634A		Z = 12	16446340/02

Les références des pièces sont indicatives.
Nos pièces ne sont pas d'origine.

Part numbers are quoted for reference purposes only.
Our parts and accessories are not original.



FLASQUE & MANCHONS CANNELES
FLANGE & SPLINED AXLES

S.135/2620
(13526200)

Flasque / Flange
Saturno, Mercury 85 Export,
Centurion 75 Export, Taurus Export 60,
Minitauro, Minitaurus 60 Synchro,
Corsaro 70 Synchro, Falcon, Aurora

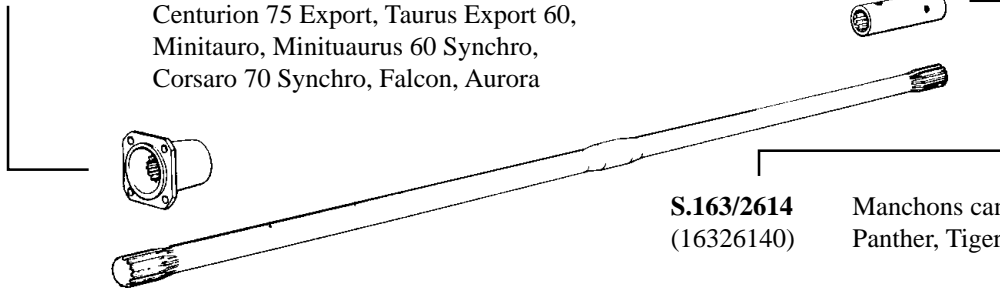

S.163/2614
(16326140)

Manchons cannelés / Splined axles
Panther, Tiger 100, Laser, Tiger Six 105

S.255/2617
(25526170)

Explorer, Explorer II, Antares
Lamborghini 674, 774, 874

KITS DE DIRECTION ASSISTEE
POWER STEERING KITS

SAME

- DA.180 ATLANTA 45 DT
- DA.181 DELFINO 2 RM,
SIRENETTA 2 RM
- DA.182 FALCON 2 RM
- DA.183 FALCON 4 RM - (A)
- DA.184 FALCON 4 RM - (A)
- DA.185 DELFINO 4 RM
- DA.186 RANGER, AURORA 2 RM
- DA.187 RANGER, AURORA 4 RM - (A)
- DA.188 CORSARO, SATURNO 2 RM
- DA.189 CORSARO, SATURNO 4 RM
- DA.190 CORSARO, SATURNO
2 RM SYNCHRO
- DA.191 CORSARO, SATURNO
4 RM SYNCHRO
- DA.192 CORSARO, SATURNO
4 RM - (A)
- DA.193 CORSARO, SATURNO
4 RM SYNCHRO - (A)
- DA.194 MINITAURO 2 RM
- DA.195 MINITAURO 4 RM
- DA.196 MINITAURUS, CONDOR
2 RM SYNCHRO
- DA.197 MINITAURUS 4 RM SYNCHRO
- DA.198 MINITAURO 4 RM - (A)
- DA.199 MINITAURUS 4 RM SYNCHRO - (A)
- DA.062 LEONE, CENTAURO 2 RM
- DA.200 LEONE, CENTAURO 4 RM
- DA.201 LEONE, CENTAURO 4 RM - (A)
- DA.202 BUFALO, PANTHER, DRAGO, 4 RM
- DA.203 BUFALO, PANTHER, DRAGO - (A)
- DA.204 SOLAR 50 2 RM
- DA.205 SOLAR 60 2 RM

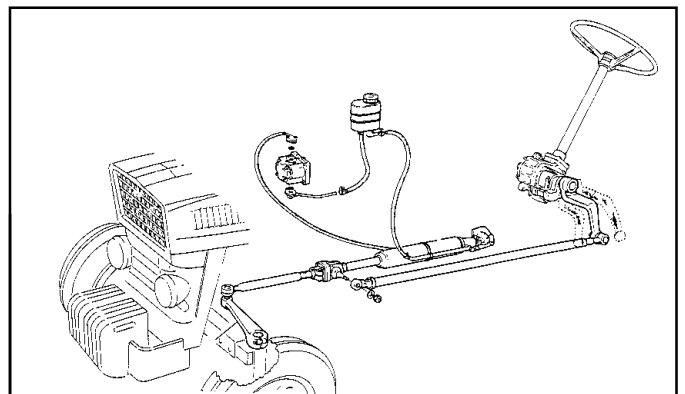

LAMBORGHINI

- DA.150 R 475 - 485 - 804 - 704
- DA.151 503 DT - 305 DT - 503 DT-B
- DA.152 503 DT/DTB - (A)
- DA.153 603 DT/DTB - (A)
- DA.154 603
- DA.155 603 DT
- DA.156 603 DT-B
- DA.157 483 DT
- DA.158 654
- DA.159 654 DT
- DA.160 354
- DA.161 660

Ces kits sont fournis avec toutes les pièces nécessaires au montage.
These kits are supplied with all parts needed for installation.
(A) Hydrostatique / Hydrostatic

KIT DE RECONDITIONNEMENT DU FILETAGE DES FUSEES DE ROUES AVANT
FRONT SPINDLE THREAD REPAIR KIT

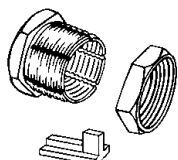

70/457-9 (Ex : LN.10-24M)

Filetage/ Thread 24 x 150mm

L'écrou cône intérieur se visse sur le filetage usé et est serré par l'écrou extérieur.
The inner cone nut is screwed on the worn thread and is locked by the outer nut.

Les références des pièces sont indicatives.
Nos pièces ne sont pas d'origine.

Part numbers are quoted for reference purposes only.
Our parts and accessories are not original.



ROTULES & TIRANTS DE DIRECTION
STEERING LINKS & SOCKETS

POSITIONS

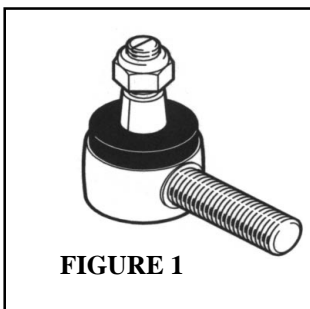
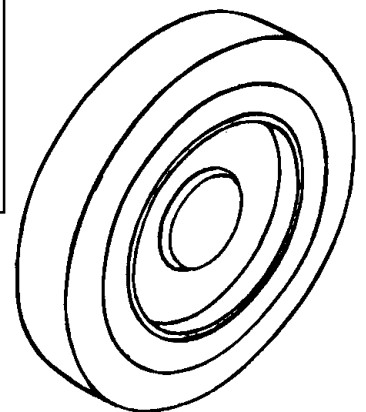
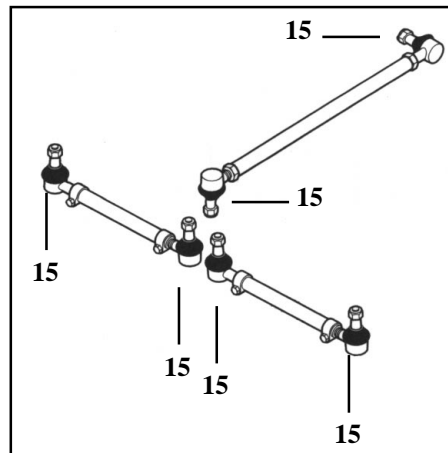
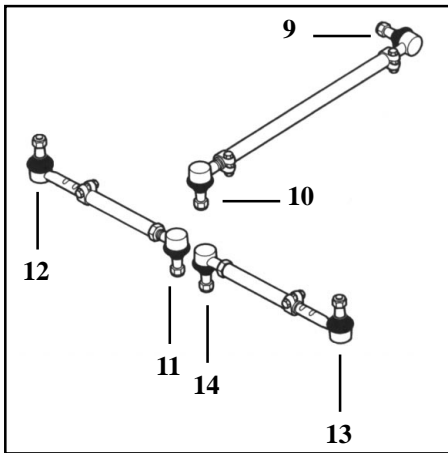
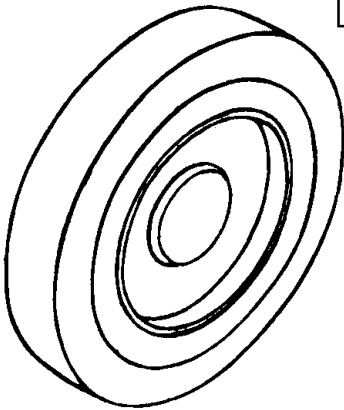
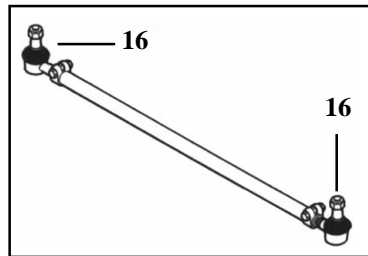
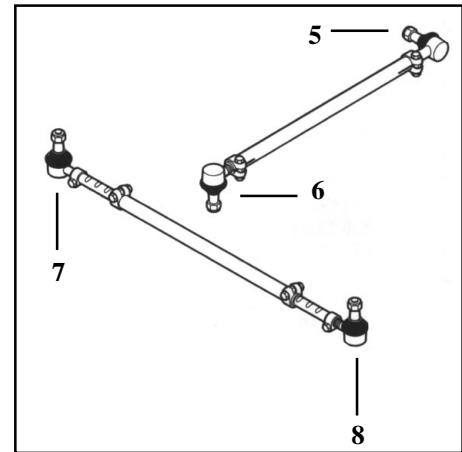
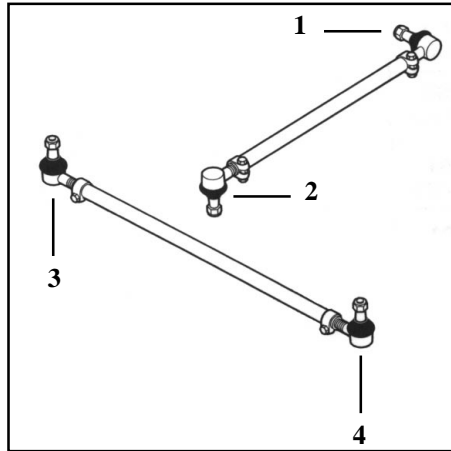

FIGURE 1

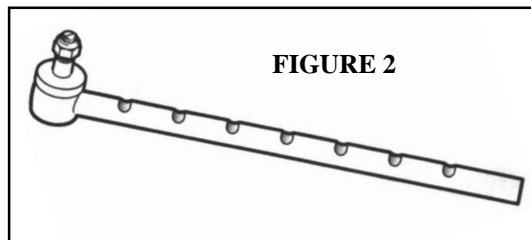

FIGURE 2

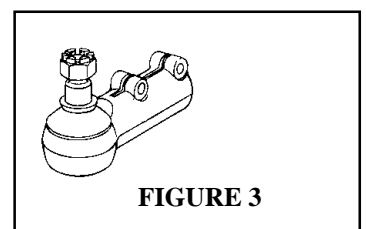

FIGURE 3

Les références des pièces sont indicatives.
Nos pièces ne sont pas d'origine.

Part numbers are quoted for reference purposes only.
Our parts and accessories are not original.



ROTULES & TIRANTS DE DIRECTION
STEERING LINKS & SOCKETS

Figures & position : consultez la planche de travail page SLH-66 / See page SLH-66 for figures & position

Tracteurs Tractors	Fig. Fig.	Position Position	Filetage ou Ø Thread or Ø	Longueur Length	Conicité Cone	
Italia DT, Atlanta DT	1	1	M18 x 1,5	100mm	16/18	
		2				
		3				
Italia Vigneto DT Atlanta Vigneto DT		4		M18 x 1,5	90mm	14/16,5
		1				
		2				
3						
Taurus 60 Minitauro DT Panther Falcon DT Condor DT		4		M24 x 1,5	100mm	16/18
		1				
		2				
		3				
Solar 50 Solar 60		4		M18 x 1,5	105mm	18/20
	3					
Solar 50DT Solar 60DT	4	M24 x 1,5	100mm	16/18		
	1					
Drago Buffalo	3	M18 x 1,5	105mm	18/20		
	4					
	3					
Tiger Six 105DT	4	M22 x 1,5	100mm	18/20		
	1					
	2					
	3					
Aurora DT, Delfino DT Sirenetta DT, Ranger 45DT Falcon, Minitauro, Vigneron DT Frutteto DT, Condor Vigneron 35, 45, 60	4	M18 x 1,5	90mm	14/16		
	5					
	6	M16 x 1,5				
	7					
Corsaro Drago Saturno Leopard	8	M22 x 1,5	100mm	16/18		
	5					
	6					
	7					
Aurora Minitaurus Taurus Italia 35 Atlanta	8	M18 x 1,5	75mm	11/12,5		
	5					
	6	M14 x 1,5				
	7					

 Les références des pièces sont indicatives.
 Nos pièces ne sont pas d'origine.

 Part numbers are quoted for reference purposes only.
 Our parts and accessories are not original.

ROTULES & TIRANTS DE DIRECTION
STEERING LINKS & SOCKETS

Figures & position : consultez la planche de travail page SLH-66 / See page SLH-66 for figures & position

Tracteurs Tractors	Fig. Fig.		Position Position	Filetage ou Ø Thread or Ø	Longueur Length	Conicité Cone
Ariete	1	S.135/4237 (13542374)	9	M18 x 1,5	100mm	16/18
			10			
Centaurus 55, 65, 70 Leone 70, 75	1	S.135/4345 (13543454)	9	M22 x 1,5	100mm	16/18
			10			
Centaurus 55, 65, 70 Leone 70, 75	2	S.135/4237 (13542374)	11	M18 x 1,5	300mm	16/18
				12		
			13			
Centaurus DT, Leone DT Corsaro DT, Saturno DT	1	S.135/4237 (13542374)	14	M18 x 1,5	100mm	16/18
				15		
Drago DT, Buffalo DT, Panther DT	1	S.148/6126 (14861264)	16	M24 x 1,5	105mm	18/20
Leopard 90, Hercules DT, Leopard DT Leopard 90 Turbo, Taurus 60 DT Tiger DT, Jaguar DT, Explorer 50 Explorer 60, 65, 70 Export Explorer 65, 75, 80 Speed Frutteto 60-75 Aster 60, 70 (4RM/4WD) Antares 100 (4RM / 4WD) Antares 110, 130 (2RM / 2WD) Centurion 75 Export (+ DT) Laser 90, 100, 110 (2RM / 2WD) Explorer II 60, 70, 80, 90 (4RM / 4WD)						
Laser 90, 100, 110, 130, 150 (4RM / 4WD) Galaxy 170 (4RM / 4WD) Titan 145, 160, 190 (4RM / 4WD)		29/257/4345 (25743454)		M24 x 1,5		20/22
Aster 60, 70 (2RM / 2WD)		S.135/4237 (13542374)		M18 x 1,5	100mm	16/18
Antares 100 (2RM / 2WD) Explorer II, 60, 70, 80, 90 (2RM / 2WD)		S.135/4345 (13543454)		M22 x 1,5		
Hürlimann Suivant applications Some applications	3	27/1730HU		M22x1,5	100mm	16/18
			27/1731HU			18/20
			27/1732HU			16/18
		27/1733HU		F36x1,5	145mm	27/29
Lamborghini R.754, R.854	1	S.135/4345 (13543454)	1	M22 x 1,5	100mm	16/18
			2			
		S.135/4237 (13542374)	3	M18 x 1,5		
			4			

 Les références des pièces sont indicatives.
 Nos pièces ne sont pas d'origine.

 Part numbers are quoted for reference purposes only.
 Our parts and accessories are not original.

ROTULES & TIRANTS DE DIRECTION
STEERING LINKS & SOCKETS

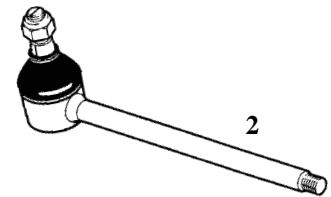
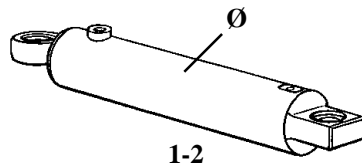
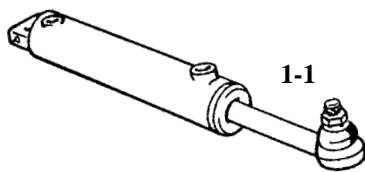

Figures	1		2		Jeu réparation du vérin Ram cylinder repair kit
Tracteurs Tractors	Vérin Ram cylinder	Remarques Comments	Tirant Rod	Remarques Comments	
Same Jaguar 95, Tiger 100, Leopard 90 Tiger Six 105, Falcon Lamborghini Hürlimann : H.480, H.490	S.169/6352 (16963524) 1-1	A : 215 B : 380 C : 24/26	S.169/6376 (16963763)	E : 340mm Ø : 22mm C : 24/26	S.169/6378 (16963786)
Same Leopard 85, Centurion 75, Centauro, Mercury DT Lamborghini : R.754, R.654	S.176/6354 (17663544) 1-1	A : 215 B : 390 C : 20/22	S.176/6360 (17663603)	E : 340mm Ø : 22mm C : 20/22	S.176/6365 (17663656)
Same Minitaurus 60, Condor 55 Taurus 60	S.193/6362 (19363624) 1-1	A : 170 B : 340 C : 20/22	S.193/6360A (19363693)	E : 290mm Ø : 22mm C : 20/22	
Tracteurs étroits Narrow tractors	S.463/6342 (46363423) 1-1	A : 215 B : 380 C : 20/22			
Same 4RM / 4WD Laser, Antares 100, 110, 130 Explorer II 70, 80, 90 Titan 145, 160, 190	29/264-6342 (26463424/10) N°970100240 Ø 57mm 1-2	A : 200 B : 358 D : Ø 20mm	NEW		
Same 2RM / 2WD Explorer II 60, 70, 80, 90, Antares 100 Same 4RM / 4WD Explorer II 70, 80, 90 Vérin standard/Standart ram cylinder Lamborghini 2RM / 2WD 674, 774, 874, 674-70, 774-70, 874-70 Hürlimann 2RM / 2WD H466, 476, 486, 478, 488 T908, 909, 910-4, 910-6	S.255/6342 (25563424) N°970440030 Ø 55mm 1-2	B : 334 D : Ø 20mm	NEW		
Same 4RM / 4WD Explorer II 70, 80, 90 Vérin renforcé/Heavy duty ram cylinder Lamborghini 4RM / 4WD 674, 774, 874, 674-70, 774-70, 874-70 Hürlimann 4RM / 4WD H466, 476, 486, 478, 488 T908, 909, 910-4, 910-6	S.448/6342 (44863424) N°980430031 Ø 62mm 1-2	B : 330 D : Ø 20mm	NEW		
Lamborghini			SLT429/6371 (42963713)	E : 295mm Ø : 20mm C : 16/18	
			SLT429/6370A (42963704)	E : 300mm Ø : 20mm C : 18/20	

(A) : Course / Stroke
(D) : Rotule / Tie rod

(B) : Longueur fermée / Closed length
(E) : Longueur tige / Length shaft

(C) : Cône / Cone

Les références des pièces sont indicatives.
Nos pièces ne sont pas d'origine.

Part numbers are quoted for reference purposes only.
Our parts and accessories are not original.



POMPES HYDRAULIQUES
HYDRAULIC PUMPS

SAME

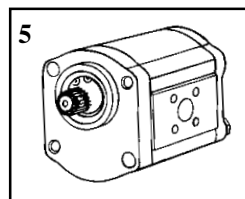
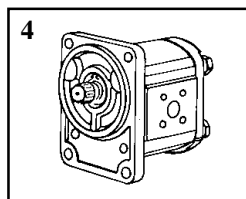
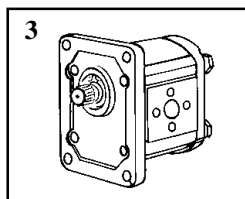
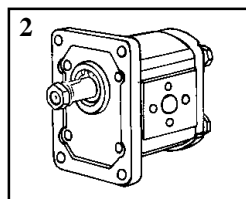
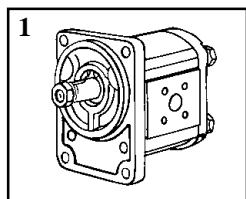

Tracteurs Tractors	Référence Reference	Fig. Fig.	Type Type	Débit Flow	Rotation Rotation	OEM
Antares 100, 110, 130	BH.515.338	5	DA	14cc	Gauche LH	245297900 245299200
Antares 100	BH.615.023		R	16cc	Droite RH	245297400
Antares 110, 130	BH.715.008		R	22,5cc		245297800
Centauro 70 exp., Centurion 75 Exp., Condor 55 Jaguar 95 Exp., Leopard 85, Leopard 85 Exp. Mercury 85 Exp., Minitaurus 60 Exp., Taurus 60 Exp. Tiger Six 105 Exp.	BH.425.307	1	DA	8cc	Gauche LH	245292700/10
Delfino 35, Falcon 50, Aurora 45, Vigneron 35, 45, 60, Ranger 45	BH.325.307 BH.425.308	4		5,5cc 8cc		245292500
Centauro 70SP, Centurion 75SP, Galaxy 170, Laser 90, 100, 110, 130, 150, Leopard 90, 90DT Mercury 85SP	BH.525.024	3	DA	11cc	Droite RH	245294200
Leopard 75C, Trident 130	29/4529-430 29/4529-480 BH.525.329			11cc 12cc 14cc		24529430, 0510525331 P78120062 24529390
Explorer 55, 60, 65, 70, 75, 80, 90	29/4529-470	5	R	8cc	Gauche LH	245294700/10 0510415328
Centauro 70SP, 70 Exp., Centurion 75SP, 75 Exp., Mercury 85SP, 85 Exp.	BH.525.329 29/4529-480 BH.625.332	3		14cc 12cc 19cc		24529390 P781200GLX 245294000
Laser 90, 100, 110, 130, Galaxy 170, Leopard 90, 90DT, Buffalo 130, Hercule 160, Jaguar 95, Tiger Six 105, Panther 95	BH.725.348			22,5cc		245293000/10
Explorer 55, 60, 65, 70, 75, 80	29/4529-440	5	R	14cc	Droite RH	0510515013 245294400/10
Explorer II, 80, 90	BH.615.023			16cc		245297400
Leopard 90	BH.525.311 SLT.4529/290	1	DA	11cc	Gauche LH	245292900 P87120061
Aster 60, 70	BH.625.315		R	16cc		
Jaguar 100, Trident 130	BH.625.327 S.4529/330	3	R	16cc 16cc		245290160 P781600GLX
Buffalo 130	BH.425.307 BH.525.024	1 3	DA	8cc 11cc	Gauche/LH Droite/RH	245292700/10 245294200

R : Relevage / Lift
DA : Direction assistée / Power steering

Références "BH..." references : Bosch
Références "29/..." & "SLT..." references : Bendix

Les références des pièces sont indicatives.
Nos pièces ne sont pas d'origine.

Part numbers are quoted for reference purposes only.
Our parts and accessories are not original.



POMPES HYDRAULIQUES
HYDRAULIC PUMPS

LAMBORGHINI

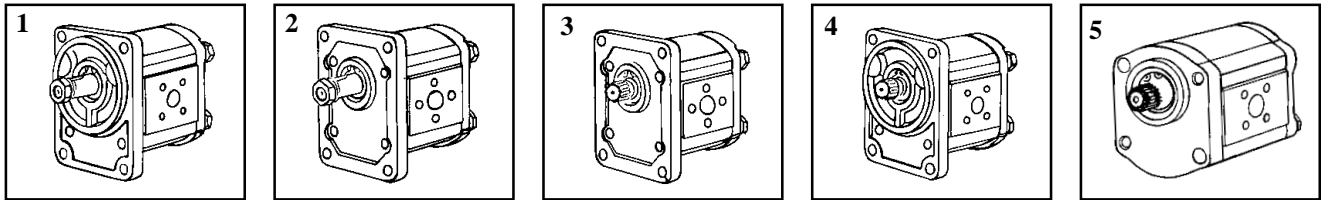

Tracteurs Tractors	Référence Reference	Fig. Fig.	Type Type	Débit (cc) Flow (cc)	Rotation Rotation	OEM	
R.235 (4666 ⇄), 503, 603, 704, A.183	BH.425.009	1	R	8	Droite / RH	245292800 640R2031	
	29/4529-280					P870800D1X	
583, 653, 654, 683, 684, 754, 784, 854, 904, 955, A.182	BH.525.313	2	DA	11	Droite / RH	245291500 640R2050	
583, 653, 654, 683, 684, 851, 904, 655, 754, 784	29/4529-430	3	R			16	Gauche / LH
1056, 1156, 1356 (⇄ 1133), 1556	BH.625.327 S.4529/330			22,5	245293300 P781600G2X		
956, 1106-1306, 1556, 1706T, 1256, 1356 (1134 ⇄), 3056	BH.725348						
754, 854, 1356	BH.625.318	2	DA	16	Droite / RH	245293100	
674, 774, 874	29/4529-470	5	R	14		Droite / RH	P650800G2 0510415328 245294700
674	29/4529-440				16		245297400
774, 874, Formula 105	BH.615.023						
956, 1106, 1306, 1506, 1706, R.105	BH.525.024	3	DA	11	Gauche / LH	245294000 640R2090	
1156, 1356	BH.625.332		R	19		245292700/10	
A.184, 684	BH.425.307	1	DA	8	Gauche / LH	245297900	
Formula 115, 135	BH.515.338	5		14		245294000	
Racing	29/4529-480	3		12		245297800	
Formula 115, 135	BH.715.008	5	R	22,5	Droite / RH	245292900 P871200G1X	
804	BH.525311 SLT.4529/290	1		11	Gauche / LH		
956, 1106,1306, 1506, 1706, 1556	BH.725.331	2		22,5			

R : Relevage / Lift

DA : Direction assistée / Power steering

Les références des pièces sont indicatives.
Nos pièces ne sont pas d'origine.

Références "BH..." references : Bosch

Références "29/..." & "SLT..." references : Bendix

Part numbers are quoted for reference purposes only.
Our parts and accessories are not original.



POMPES HYDRAULIQUES
HYDRAULIC PUMPS

HÜRLIMANN

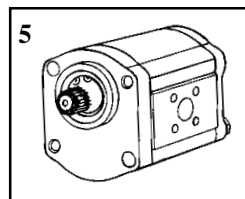
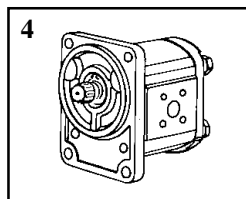
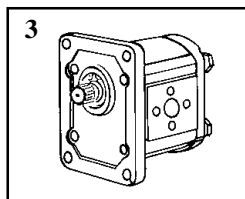
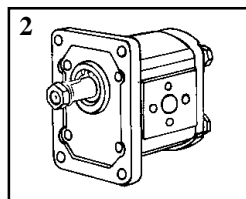
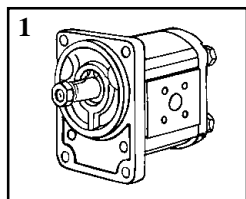

Tracteurs Tractors	Référence Reference	Fig. Fig.	Type Type	Débit (cc) Flow (cc)	Rotation Rotation	OEM	
H.5110	BH.625.315	1	R	16	Gauche / LH		
H.6130	BH.625.317	4		16			
H.6160	BH.625.316			19			
H.6135	BH.515.338	5	DA	14		245297900	
H.468, H.478, H.488	BH.615.023		R		16	Droite / RH	
H.496, H.5116, H.6136, H.6170	BH.725.331	2			22,5		
	BH.725.348	3					
H.360, H.470, H.480	B.525.313	2	DA	11	Gauche / LH	245293600	
H.5110, H.360, H.470, H.480, H.490	BH.525.311	1					Bendix
	SLT.4529/290						
H.490	BH.525.311	3	R				
	SLT.4529/290						
H.496	BH.525.024	3	DA		Droite / RH		
H.356, H.466, H.478, H.488	29/4529-470	5			8	Gauche / LH	0510415328

R : Relevage / Lift
DA : Direction assistée / Power steering

Références "BH..." references : Bosch
Références "29/..." & "SLT..." references : Bendix

Liste de conversion des anciennes références TRACPIECES
Cross-reference previous TRACPIECES numbers

Ancienne référence Previous reference	Nouvelle référence New reference	Ancienne référence Previous reference	Nouvelle référence New reference
S.4529/005B	BH.425.308	S.4529/300	BH.525.748
S.4529/006S	BH.325.307	S.4529/016	BH.625.327
S.4529/009	BH.425.307	SLT.4529/570	BH.425.009
S.4529/015	BH.525.329	27/1740HU	BH.525.313
S.4529/420	BH.525.024	SLT.4529/310	BH.625.318

Les références des pièces sont indicatives.
Nos pièces ne sont pas d'origine.

Part numbers are quoted for reference purposes only.
Our parts and accessories are not original.



DISTRIBUTEURS HYDRAULIQUES
HYDRAULIC VALVE

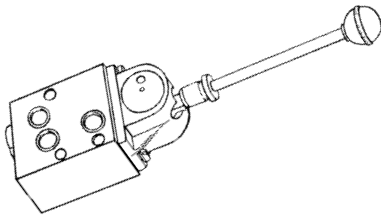

HB.47/SA Simple effet / *single acting*

HB.47/DA Double effet / *double acting*

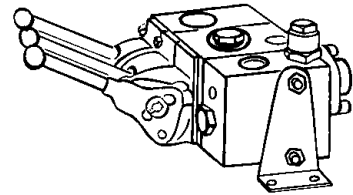

STABILISATEURS
STABILISERS

STABILISATEURSAVEC POSITION FLOTTANTE
STABILISER WITH FLOATING POSITION

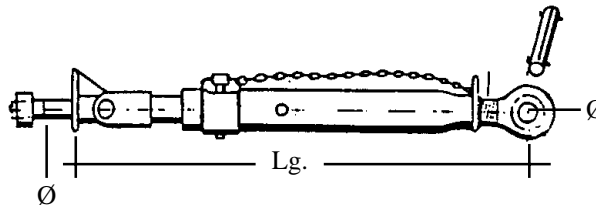

Réf. Ref.	Lg. fermée Closed Lg.	Lg. ouverte Opened Lg.	Ø Piton Ø Pin	Ø Rotule Ø Tie rod	Flottement Floating	Filetage Thread
AT.9001/E	410	510	18	19	30	M27x3
AT.9002/D	490	630	28			
AT.9003/C	600	710				
AT.9004/B	580	700		25	40	M36x3
AT.9005/A	680	830				

STABILISATEUR TYPE ORIGINE
STABILISER GENUINE TYPE

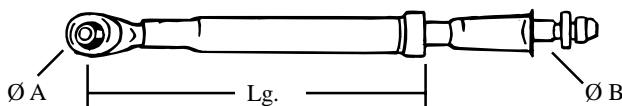

S.9605/426 Lg. : 386mm
ØA : 19mm
ØB : 20mm

S.9605/1506 Lg. : 350mm
ØA : 19mm
ØB : 28mm

GOUPILLE
SAFETY PIN



S.96017/514 Ø 14mm
S.96001/574 Ø 16mm
S.96026/553 Ø 20mm

Les références des pièces sont indicatives.
Nos pièces ne sont pas d'origine.

Part numbers are quoted for reference purposes only.
Our parts and accessories are not original.



TIRANTS DE RELEVAGE
LIFTING RODS

BRAS DE RELEVAGE
LIFT ARM

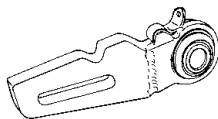

- S.9605/354** Extrémité droite / *Outside RH*
Leopard, Tiger, Panther
Cat.2, Ø 28
- S.9605/355** Extrémité gauche / *Outside LH*
Leopard, Tiger, Panther
Cat.2, Ø 28

VERIN D'ASSISTANCE DE RELEVAGE
RAM CYLINDER LIFT ARM

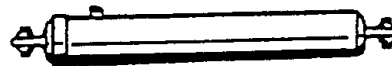

- HYSE.298** Ø tige 40mm / Ø rod 40mm
2 rotules Ø 22mm / 2 tie rods Ø 22mm
Lg. fermée entre-axes : 550mm
Lg. closed : 550mm
Course : 380mm / Stroke : 380mm

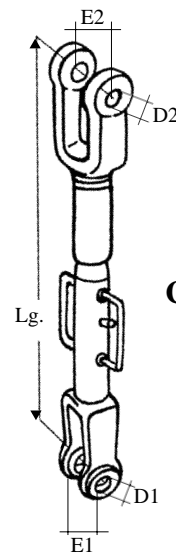
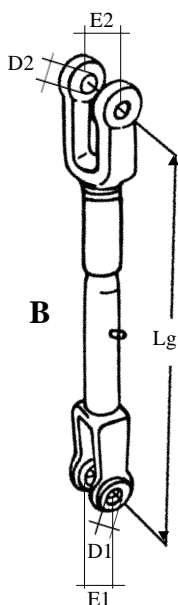
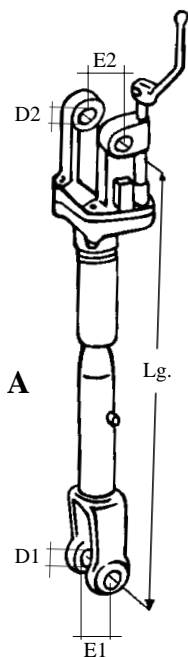

Réf. Ref.	Description Description	Type Type	L (mm)	D1 Ø (mm)	D2 Ø (mm)	E1 (mm)	E2 (mm)
29/76057 (76057354)	Tirant réglable / <i>Adjustable rod</i> Explorer 80, 90 + Ancienne gamme / <i>Old range</i>	A	680	24	24	30	45
29/76036 (76035364)	Tirant fixe / <i>Fixed rod</i> Explorer 60, 70 Lamborghini 874-90DT	B	645			25	45
29/76058 (76057364)	Tirant fixe / <i>Fixed rod</i> Explorer 80, 90		680				
29/96047 (96047364)	Tirant fixe / <i>Fixed rod</i> Laser 110, Antares 110, 130, 150		735				
29/76039 (*) (76039354)	Tirant gauche ou droit / <i>Rod (LH or RH)</i> Titan 160	C	820	28	28	32	51

(*) Livrable jusqu'à épuisement des stocks / *Stocks in exhaust*

Les références des pièces sont indicatives.
Nos pièces ne sont pas d'origine.

Part numbers are quoted for reference purposes only.
Our parts and accessories are not original.

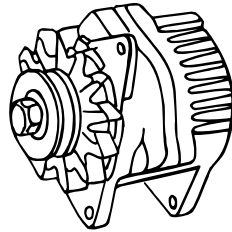

ALTERNATEURS
ALTERNATORS
SAME

Tracteurs Tractors	Réf. Cde Order N°	Remarques Observations	Capacité Capacity	Régulateur Regulator	OEM
Falcon, Panther, Buffalo, Minitauro, Saturno	510.E.385	Montage à droite <i>RH assembling</i>	14V., 35 Amp.	Séparé / <i>Separate</i> : 205/01001	294390700 9AL2969F
Buffalo 130, Centauro 70, Centurion 75, Condor 55, Corsaro, Delfino 35, Drago 120, Falcon, Jaguar 95 & 100, Leopard, Mercury, Panther 90, Taurus 60, Tiger 100, Vigneron 35, 50 & 70	SLT.9439/090		14V., 33 Amp.	205/01007	294390900
	510.E.414 15/1071	VALEO Raccord à fiches <i>Plug connection</i>	14V., 45 Amp. 14V., 55 Amp.	505.E.106 205/04034	294391300 9AR50066
	15/1405 (W)	Raccord à vis Montage à droite <i>Screw connection</i> <i>RH assembling</i>	14V., 55 Amp.	205/05122	
Antares 100, 110 & 130, Aster 60, Explorer 55, 65, 75 & 85, Centauro 70 & 75, Galaxy, Hercules 60, Jaguar 95 & 100, Laser 90, 100, 110, 130, 150, Leopard 85 & 90, Mercury 85, Panther 95, Taurus 60, Tiger Six 105	15/1242	Raccord à vis, Sans poulie <i>Screw connection</i> <i>Without pulley</i>	14V., 55 Amp.	205/05122	294391300
	15/8463 (W)	Sans poulie <i>Without pulley</i>	14V., 65 Amp.	205/05122	
	15/1357 (W)	Raccord à vis, Poulie double déportée <i>Screw connection</i> <i>Twin pulley (offset)</i>	14V., 65 Amp.	205/04034	294392900
	15/1336 (W)	Raccord à vis, Poulie simple <i>Screw connection</i> <i>Single pulley</i>	14V., 55 Amp.	205/04034	
Solar, Titan, Explorer, Antares	15/5514	Pour chauffage Sans poulie <i>For heating</i> <i>Without pulley</i>	14V., 65 Amp.	Sans régulateur <i>Less regulator</i> Séparé / <i>Separate</i> : 16.906.339	
Corsaro 70, Panther 90, Leopard 85, Saturno 80, Tiger 100	15/1405 (W)	Raccord à vis <i>Screw connection</i>	14V., 55 Amp.	205/05122	9AR2968K
Silver 80, 90, 100-4, 100-6	15/1667	Pour chauffage Rotation gauche <i>For heating</i> <i>LH rotation</i>	14V., 85 Amp.	AER1606	294394700
Ancien montage <i>Old Assembly</i>	510.E.384	VALEO Axe/ <i>Shaft</i> : Ø 17mm	14V., 50 Amp.	505.E.079	
	15/1309 (W)		14V., 55 Amp.	205/05122	

 (W) Raccordement électrique du compteur / *Electrical tachometer connection*

 Les références des pièces sont indicatives.
 Nos pièces ne sont pas d'origine.

 Part numbers are quoted for reference purposes only.
 Our parts and accessories are not original.

ALTERNATEURS
ALTERNATORS

LAMBORGHINI

Tracteurs Tractors	Réf. Cde Order N°	Remarques Observations	Capacité Capacity	Régulateur Regulator	OEM
360, 483	15/1995		14V., 33 Amp.	205/01007	
503, 603, 704, 804, 904	K.552 (W)		14V., 33 Amp.	205/01007	
553, 653, 654, 683, 684, 754, 784, 854	SLT.9439/090		14V., 33 Amp.	205/01007	294390900
674, 774, 874, 956, 1106, 1156, 1256, 1306, 1356, 1506, 1706	15/1242	Raccord à fiches <i>Plug connection</i>	14V., 55 Amp.	205/05122	294391300
	15/8463 (W)	Sans poulie <i>Less pulley</i>	14V., 65 Amp.	205/05122	
	15/1357 (W)	Raccord à fiches <i>Plug connection</i> Poulie double déportée <i>Twin pulley (offset)</i>	14V., 65 Amp.	205/04034	

HÜRLIMANN

Tracteurs Tractors	Réf. Cde Order N°	Remarques Observations	Capacité Capacity	Régulateur Regulator	Réf. OEM Ref. OEM
H356, 466, 466-4, 476, H486T, 6170T, 6670, 6680, 6690, 8610, 8630	15/1242 15/8463 (W)	Sans poulie <i>Less pulley</i>	14V., 55 Amp. 14V., 65 Amp.	205/05122 205/05122	

(W) Raccordement électrique du compteur / *Electrical tachometer connection*

PIECES DIVERSES POUR DYNAMO "BOSCH"
MISCELLANEOUS PARTS FOR "BOSCH" GENERATOR

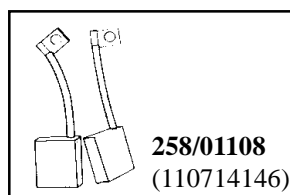
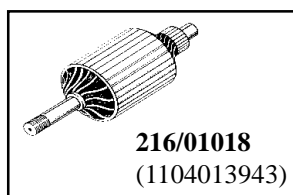

PIECES DIVERSES POUR ALTERNATEURS D'ORIGINE
MISCELLANEOUS PARTS FOR ORIGINAL ALTERNATORS

Balai / *Brushe*

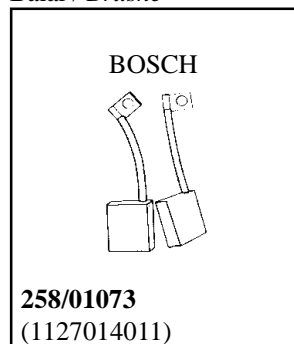

Bloc balai / *Brushe set*

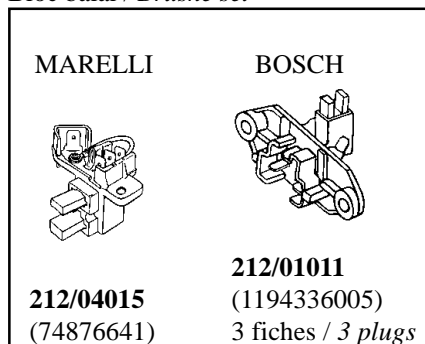

Régulateur / *Control box*

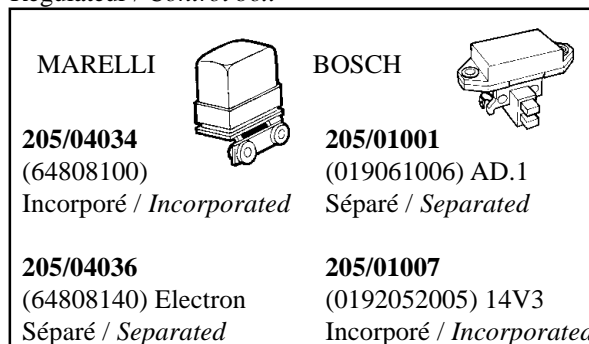

Les références des pièces sont indicatives.
Nos pièces ne sont pas d'origine.

Part numbers are quoted for reference purposes only.
Our parts and accessories are not original.

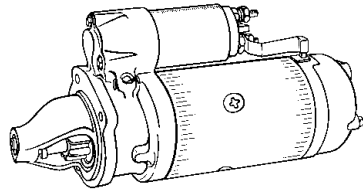

DEMARREURS
STARTER MOTORS

SAME

Tracteurs Tractors	Réf. Cde Order N°	Lanceur Drive ass.	Fixation Fitting	Lg. sortante Prominent lg.	Capacité Capacity	OEM
Antares 110, 130 & 150, Explorer 80 & 90, Galaxy 170, Laser 110, 130 & 150 (Certains / Some)	S.9619/180N	9Z	2L	254mm	12V., 3,5 KW	296192300
Minitauro 55/60, Corsaro 70, Delfino, Explorer 60, Falcon, Aurora, Saturno	S.9619/080	11Z	2L	224mm	12V., 1,8 KW	296190800
Antares 110 & 130, Drago 120, Buffalo 130, Centauro 70, Centurion 75, Condor 55, Corsaro 70, Explorer 55, 65, 75 & 85, Galaxy 170, Herculus 160, Jaguar 95 & 100, Laser 90, 110, 130, 150 (3/83 ⇄ 12/87) Leopard 85 & 90, Mercury 85, Minitauro 60, Minitaurus 60, Panther 90 & 95, Saturno 80, Solar 60, Taurus 60, Tiger 100, Tiger Six 105, Titan 160 & 190	SLT.9619/110	11Z	2L	254mm	12V., 3,5 KW	296191800

LAMBORGHINI

Tracteurs Tractors	Réf. Cde Order N°	Lanceur Drive ass.	Fixation Fitting	Lg. sortante Prominent lg.	Capacité Capacity	OEM
503, 603 (3/71 ⇄)	SLT.2040	9Z	2L	228mm	12V., 2,7 KW	
235, 653, 784	S.9619/080	11Z	2L	224mm	12V., 1,8 KW	296190800
804, 904	SLT.073	9Z	3L	262mm	12V., 3 KW	296195000
235, 345, 503, 603, 613, 653, 654, 674, 684, 704, 714, 754, 774, 784, 804, 854, 874, 955, 1056, 1156, 1256, 1556, 574-60, 874-90, 674-70, 774-80	SLT.9619/110	11Z	2L	254mm	12V., 3,5 KW	296191800
503, 603, 1106, 1306, 1506, 1706, 1356, 674-70, 774-80, 874-90 Formula 115, 135	S.9619/180N	9Z	2L	254mm	12V., 3,5 KW	296192300

HÜRLIMANN

Tracteurs Tractors	Réf. Cde Order N°	Lanceur Drive ass.	Fixation Fitting	Lg. sortante Prominent lg.	Capacité Capacity	OEM
H355, 360, H470, 480, 490, H5110, H6110, H476U, H488T, 496T, 5116T, 6115, 6130, 6135, 6136, 6160, 6165, 6190	SLT.9619/110	11Z	2L	254mm	12V., 3,5 KW	296191800
356, 468, 478, H468-70, 468L, LA, B, H468-80, 488-90, 5116, 6170T, 6136	S.9619/180N	9Z	2L	254mm	12V., 3,5 KW	296192300

Les références des pièces sont indicatives.
Nos pièces ne sont pas d'origine.

Part numbers are quoted for reference purposes only.
Our parts and accessories are not original.

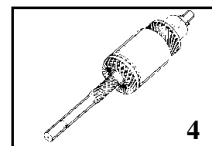
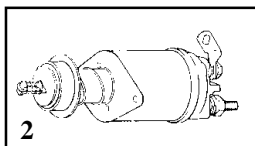
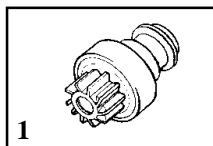

PIECES DE RECHANGE POUR DEMARREURS "BOSCH"
SPARE PARTS FOR "BOSCH" STARTER MOTORS

Figures		1	2	3	4
Tracteurs Tractors	Démarrreur Starter motor	Lanceur Drive ass.	Relais Solenoid	Jeu de balais Brushes	Induit Armature
Ariete, Drago (11/71 ⇔ 2/73)	0.00.1359.013	224/01061 (2006209301)	203/01056 (0331401001)	258/01056B (2007014052)	
Atlanta, Centauro, Delfino, Italia Minitauro (1/72 ⇔ 12/73), Sametto	0.00.1362.099	224/01122 (2006209245)	203/01063 (0331401032)	258/01058 (2007014053)	220/01048 (2004004072)
	0.00.1362.009				220/01034 (2004004061)
Aurora (11/71 ⇔ 2/73), Corsaro (2/72 ⇔ 6/76), Falcon 983L Saturno (3/72 ⇔ 6/76)	0.00.1362.022	224/01269 (200620475)	203/01065 (0331402003)	258/01059 (2007014057)	220/01059 (2004004074)
Aurora (3/73 ⇔), Centurion (9/78 ⇔) Condor (2/79 ⇔), Corsaro (7/76 ⇔) Delphino (1/72 ⇔ 9/80) Falcon (7/75 ⇔ 9/80), Jaguar Leopard (1/78), Minitauro (⇔ 9/80) Panther (2/79 ⇔), Saturno (7/76 ⇔) Sirenetta (1/72 ⇔), Taurus (11/78 ⇔) C.352, 553, 653, 503 (7/76 ⇔) 784 (1/80 ⇔)	0.00.1362.035				
Buffalo (7/74 ⇔ 1/75) Drago (3/73 ⇔ 1/75) Panther (7/74 ⇔ 1/75) C.603, R.704, 804, 904 (73/75)	0.00.1359.053	224/01189 (2006209408)	203/01057 (0331401004)	258/01056B (2007014052)	
Buffalo (2/75 ⇔ 7/79) Drago (2/75 ⇔ 7/79) Panther (2/75 ⇔ 7/79) C.603, R.704, 804, 904 (75/78) R.1056, 955	0.00.1359.099	224/01134 (2006209438)	203/01069 (0331402002)		
	0.00.1359.108				
Leone (1/67 ⇔ 12/71) C.603, R.704, 804, 904 (4/73 ⇔ 10/73) 955	0.00.1359.004	224/01058 (2006209302)	203/01056 (0331401001)		
R.503, 603 (3/71 ⇔)	0.00.1362.040	224/01149 (2006209476)	203/01064 (0331402001)	258/01059 (2007014057)	
R.1256 (6/78 ⇔), R.955, R.1056	0.00.1367.005	224/01150 (2006209492)	203/01069 (0331402002)	258/01062 (2007014062)	

Les références des pièces sont indicatives.
Nos pièces ne sont pas d'origine.

Part numbers are quoted for reference purposes only.
Our parts and accessories are not original.



DIVERS
MISCELLANEOUS

**LA MEILLEURE
PEINTURE DU MARCHE**



64/LA.2036/L
64/LA.1004/L

Bleu foncé / *Drak blue* - Lamborghini
Blanc avorio / *Avorio white* - Lamborghini

64/LA.2034/L
64/LA.2034/SP
64/LA.3034/L
64/LA.3034/SP
64/LA.6034/L
64/LA.6034/SP

Bleu / *Blue* - Same
Bleu / *Blue* - Same
Orange / *Orange* - Same
Orange / *Orange* - Same
Gris chassis / *Chassis grey* - Same
Gris chassis / *Chassis grey* - Same

**THE BEST PAINT ON
THE MARKET**

(1 litre / 1 liter)
(1 litre / 1 liter)

(1 litre / 1 liter)
(Spray)
(1 litre / 1 liter)
(Spray)
(1 litre / 1 liter)
(Spray)



**SIGLE
MEDALLION**



29/174006

Ø 80,5mm
Plastique / *Plastic*

61/830-301

(Ex : 1050/BON)



SIEGE COMPLET / COMPLETE SEAT

Caractéristiques techniques

- Modèle spécial pour les montages où l'espace arrière est limité
- Réglage en hauteur
- Glissières
- Revêtement synthétique noir

Technical data

- *Special model to fit where rear space is limited*
- *Height adjustment*
- *Slide rails adjustment*
- *Synthetic black leather*

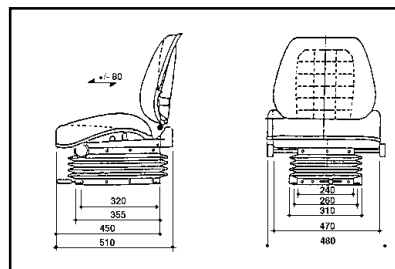

**REGARNITURES DE SIEGES
SEAT TRIMS**



S.157/751H

Siège Grammer
Seat Grammer

S.165/7518H

Siège Bostrom
Seat Bostrom

Les références des pièces sont indicatives.
Nos pièces ne sont pas d'origine.

*Part numbers are quoted for reference purposes only.
Our parts and accessories are not original.*



ELEMENTS DE CABINES
CABS ELEMENTS

RACLETTES D'ESSUIE-GLACE
WIPER BLADES

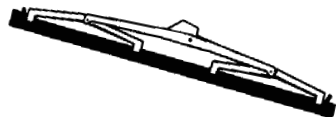

10/3223 Balai assemblé / Wiper blade
Lg. : 400-410mm

10/3225 Balai assemblé / Wiper blade
Lg. : 450-460mm

MOTEUR D'ESSUIE-GLACE
WIPER MOTOR

ET.12032

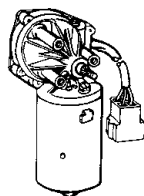

R/404A

SUPPORT DE RETROVISEUR
MIRROR BRACKET

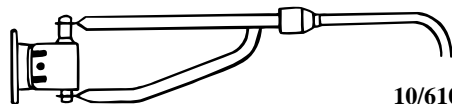

10/6100K
(0083741437429)

Support extensible pour rétroviseur (Gauche ou droit)
Sans cuvette
Extensible bracket for mirror (LH or RH)
Less mirror

RETROVISEURS
REAR VIEW MIRRORS

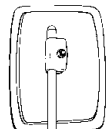

29/9234.147 Rétroviseur droit
Mirror RH



29/9234.149 Rétroviseur gauche
Mirror LH



29/9233.183 Cuvette 237x180mm
Mirror 237x180mm

29/9200.147 Cuvette 354x169mm
Mirror 354x169mm

PIECES DE PORTE DE CABINE
DOOR PARTS CAB

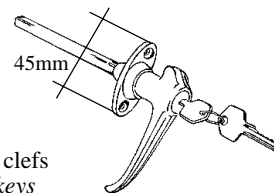

6734 - Poignée avec clefs
(92001726/10) Handle with keys
Cabine "SIAC" Cab

6821 - Poignée intérieure
(9200158020) Inner handle
Cabine "SIAC" Cab

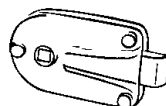

29/9200-156 - Serrure droite
Lock (RH)

29/9200-155 - Serrure gauche
Lock (LH)



ETAIS A GAZ
GAS STRUTS



SAME

Tracteurs Tractors	Pare-brise Windscreen	Porte Door	Toit Roof	Vitre arrière Rear glas
Antares, Titan	29/9206-194 (9200.170.3) 255mm	29/872-23 (00820894/20) 390mm	SLT.9234/373 320mm	29/872-37 (00754070) 715mm
Aster				SLT.9208/140 515mm - 350 Newtons
Centaurus		S.9206/194 500mm		
Centurion, Leopard Buffalo		SLT.9241/140 (92411404) 500mm	SLT.9234/373 320mm	S.9206/194 500mm - 220 Newtons
Explorer				SLT.9208/140 515mm - 350 Newtons
Explorer II, 60, 70, 80, 90		SLT.9233/167 502mm - 230 Newtons		
Galaxy			29/870-38 (92061984/10)	
Hercules				
Jaguar		SLT.9208/140 515mm - 350 Newtons		
Laser		SLT.9234/373 320mm	SLT.9233/167 502mm - 230 Newtons	
Solar				
Taurus		SLT.9241/140 500mm	SLT.9208/140 515mm - 350 Newtons	S.9206/194 500mm - 220 Newtons
Tiger, Trident				SLT.9208/140 515mm - 350 Newtons

Les références des pièces sont indicatives.
Nos pièces ne sont pas d'origine.

Part numbers are quoted for reference purposes only.
Our parts and accessories are not original.



ETAIS A GAZ
GAS STRUTS

LAMBORGHINI

Tracteurs Tractors	Pare-brise Windscreen	Porte Door	Toit Roof	Vitre arrière Rear glas
R.674, R.874	SLT.9241/140 (9233.166.4) 500mm	SLT.9241/140 (9233.166.4) 500mm	SLT.9234/373 320mm	SLT.9241/140 (9233.166.4) 500mm - 200 Newtons
R.956, R.1106, R.1306, R.1506				
R.774				SLT.9233/167 502mm - 230 Newtons
R.774-80, R.874T				
R.874-90T, R.874-90T Grand Prix, 105 Formula		SLT.9241/140 (9233.166.4) 500mm		
Hürlimann XT Lamborghini Premium		29/872-23 (00820894/20) 390mm		29/872-37 (00754070) 715mm

HÜRLIMANN

Tracteurs Tractors	Pare-brise Windscreen	Porte Door	Toit Roof	Vitre arrière Rear glas
H356, H358, H466 H476, H468, H478, H488		SLT.9241/140 (92411404) 500mm	SLT.9234/373 320mm	29/872-38 (92061984/10) 520mm - 200 N
490, 5110, 480				
XT				29/872-37 (00754070) 700mm - 350 N
6115, 6135		29/872-23 (00820894/20) 385mm - 570 N		

Les références des pièces sont indicatives.
Nos pièces ne sont pas d'origine.

Part numbers are quoted for reference purposes only.
Our parts and accessories are not original.



BAGUES D'ETANCHEITE
OIL SEALS

Dimensions Ø Dimensions Ø	Réf. SAME Ref. SAME	Type Type	Réf. Ref.	Dimensions Ø Dimensions Ø	Réf. SAME Ref. SAME	Type Type	Réf. Ref.
12x20x7	2.1519.042.0		29/1519.042	58x80x10	2.1519.001.0 (2.1519.010.0)	SP	29/1519.010
30x40x7	2.1510.013.0		29/1510.013	58x80x10	2.1520.130.0	2	29/1520.130
34x52x10/13	2.1510.216.0 (2.1520.116.0) (2.1529.010.0)	3	29/1510.216	60x75x8	2.1510.031.0 (2.1520.131.0)	2	29/1520.131
34x46x10	2.1529.021.0	3	29/1529.021	65x85x10	2.1510.331.0		29/1510.331
35x47x7	2.1510.017.0		29/1510.017	60x80x10	2.1520.231.0	2	29/1520.231
35x62x10	2.1510.617.0 (2.1529.030.0)	3	29/1510.617	70x85x8	2.1510.036.0		29/1510.036
35x62x12	2.1520.217.0	2	29/1520.217	70x90x10/12	2.1510.136.0 (2.1520.036.0) (2.1529.004.0)	3	29/1529.004
35x72x12	2.1520.317.0	2	29/1520.317	70x100x10	2.1520.336.0	2	29/1520.336
35x55x10	2.1529.033.0	3	29/1529.033	70x100x12	2.1529.026.0	3	29/1529.026
38x50x7	2.1510.019.0		29/1510.019	70x90x12/9,5	2.1529.072.0	3	29/1529.072
38x52x7	2.1510.119.0		29/1510.119	80x100x10/13	2.1510.041.0 (2.1529.005.0) (2.1520.141.0)	3	29/1520.141
40x56x8	2.1510.120.0		29/1510.120	85x110x12	2.1529.501.0 (2.1520.043.0)	2	29/1529.501
40x80x10	2.1520.420.0	2	29/1520.420	95x120x13	2.1510.447.0		29/1510.447
40x68x10/13	2.1529.016.0	3	29/1529.016	98x120x13	2.1519.002.0 (2.1519.009.0)	SP	29/1519.009
42x56x7	2.1510.021.0		29/1510.021	100x120x12	2.1510.049.0 (2.1520.049.0)	2	29/1520.049
42x60x10	2.1510.221.0		29/1510.221	100x125x12	2.1510.149.0 (2.1529.013.0)	3	29/1529.013
45x62x10	2.1510.123.0 (2.1520.023.0)	2	29/1520.023	110x140x13	2.1529.056.0		29/1529.056
45x65x10	2.1510.223.0 (2.1520.123.0) (2.1529.031.0)	3	29/1529.031	110x130x13	2.1529.073.0	3	29/1529.073
45x62x10	2.1529.036.0 (2.1529.029.0)	3	29/1529.036	125x150x13	2.1529.040.0	3	29/1529.040
45x62x16	2.1529.078.0	3	29/1529.078	130x160x12	2.1510.055.0	3	29/1510.055
48x62x8	2.1510.025.0		29/1510.025	135x160x15	2.1529.023.0	3	29/1529.023
50x72x10/8	2.1510.426.0		29/1510.426	145x180x15	2.1529.006.0 (2.1529.064.0)	3	29/1529.064
50x68x10	2.1520.026.0	2	29/1520.026	145x170x13	2.1529.038.0	3	29/1529.038
50x72x10	2.1529.041.0	3	29/1529.041	150x180x15	2.1529.065.0 (2.1529.002.0)	3	29/1529.065
55x72x12	2.1510.129.0 (2.1520.329.0) (2.1529.032.0)	3	29/1529.032	180x205x23	2.1529.081.0/20	3	29/1529.081
55x80x10	2.1529.022.0	3	29/1529.022	240x270x25	2.1529.069.0	3	29/1529.069

 (2) Double lèvre / *Twin lip*

 (3) Triple lèvre, carcasse acier / *Triple lip, steel armature*

 (SP) Spécial / *Special*

 Les références des pièces sont indicatives.
 Nos pièces ne sont pas d'origine.

 Part numbers are quoted for reference purposes only.
 Our parts and accessories are not original.